

CHAIRS

Valea

**ICF**



*Office landscape*



## The VALEA Collection

Office landscape

Comfort generates from elegance: this is the essence of the VALEA collection, a series of different sizes and models of armchairs to satisfy a range of needs.

The collection's distinctive feature is its curved, essential aluminium structure, the base of a completely padded seat covered in fabric or leather to "envelope" the user in comfort. An authentically relaxing chair.

**VALEA** Elle

---



ESSENTIAL LINE



Curved lines are reflected with expertise by the versatility of aluminium, which conveys a sense of strength and lightness at the same time. The broad and extremely comfortable seat is finished with elegance in every detail.

Solidity and expertise meet comfort and aesthetics. This is the beginning of VALEA ELLE, a chair with an essential but captivating line, designed mainly as the executive model of the Collection.

In its simplicity, VALEA ELLE lends strength to the room where it is placed because of the details that highlight its line.

THREE BACKREST HEIGHTS



Available with high, low-height backrests or headrests, VALEA ELLE transmits an image of authority and pleasant warmth, giving the office environment a distinctive style. Stylistic details such as attention to finishes and variety of colours give the product a strong personality and a modern style.

HIGHLIGHTS

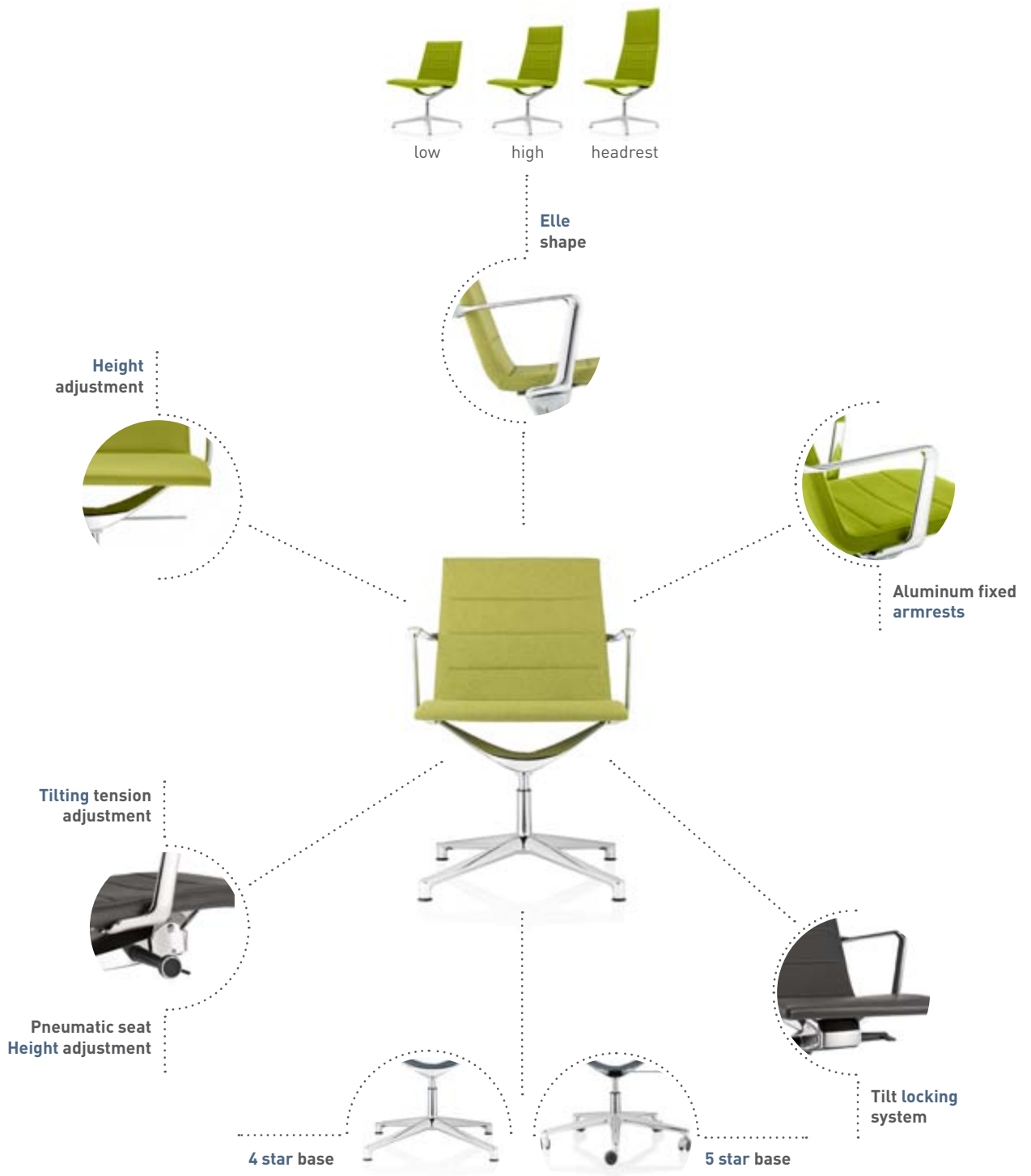

TILTING MECHANISM



**Tilting mechanism**

Valea Chair has a simple, very effective tilting mechanism that promotes movement and provides a high level of comfort, reducing stress and strains.

The rearward seat tilting mechanism pivots from the front of the chair, so that the angle is downward motion, relieving leg stress points and allowing stability in foot position on the rearward tilt. The tilting system has an adjustable tension control according to the user's weight and is lockable in various positions.

TILTING TENSION

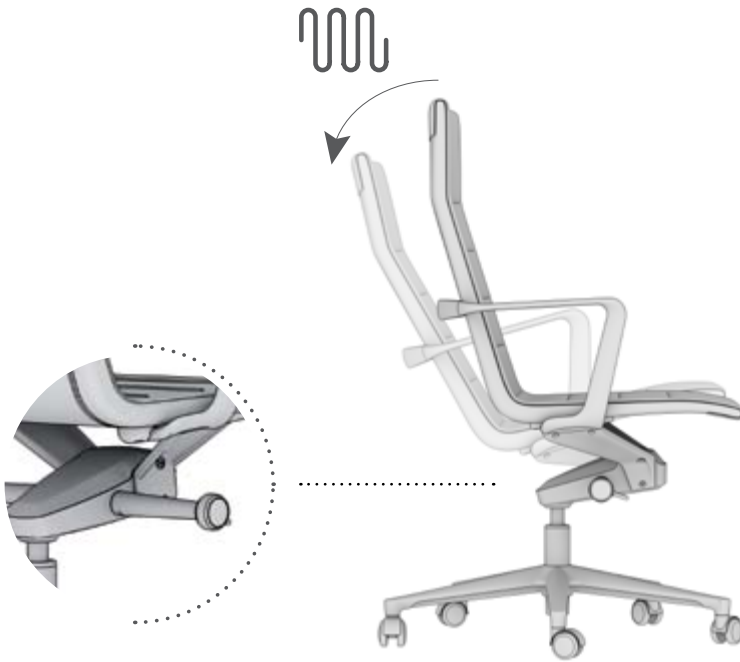

**Tilting tension**

The handle, on the right side, enables the spring tension adjustment of the tilting mechanism.

This is a function of the height and weight of an individual. The taller and/or heavier the person, the need for a tighter tilt tension. The opposite for a shorter, lighter person, the lighter the control. If the Tilt Tension is set too light for an individual, when they sit in the chair, they may have the sensation of going over backwards. Conversely, if the tension is set too tight, a smaller individual may not be able to tilt the chair at all.

TILT LOCK



**Tilt lock**

The lever on the left side of the seat enables the user to lock/unlock the tilting mechanism in different positions.

Tilt lock allows the user to sit in an upright position for keyboarding, while providing a comfortable rocking/reclining motion during meetings, phone calls and reading activities.



HEIGHT ADJUSTMENT



**Height adjustment**

The lever on the right side enables the height adjustment of the seat. The range is 12 cm.

The 5 star base model has a height adjustment column that allows to adjust the chair individually according to different heights of users and sitting habits. The heights adjustment column allows height regulation in any position along the total stroke through internal movement of gas. It is controlled by pulling up a simple, well visible and intuitive lever.

RETURN MECHANISM

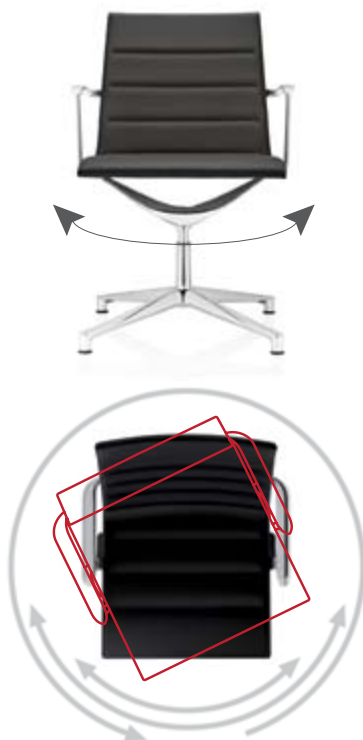

**Return mechanism**

This mechanism is standard on models with four star base, and pull the seat back to its original position.

The 4 star base has a special column that allows free-swiveling in use and that automatically rotates backrest to a frontward facing position. The fixed height column helps to keep your meeting room always in an ordinate manner.

DIMENSIONS

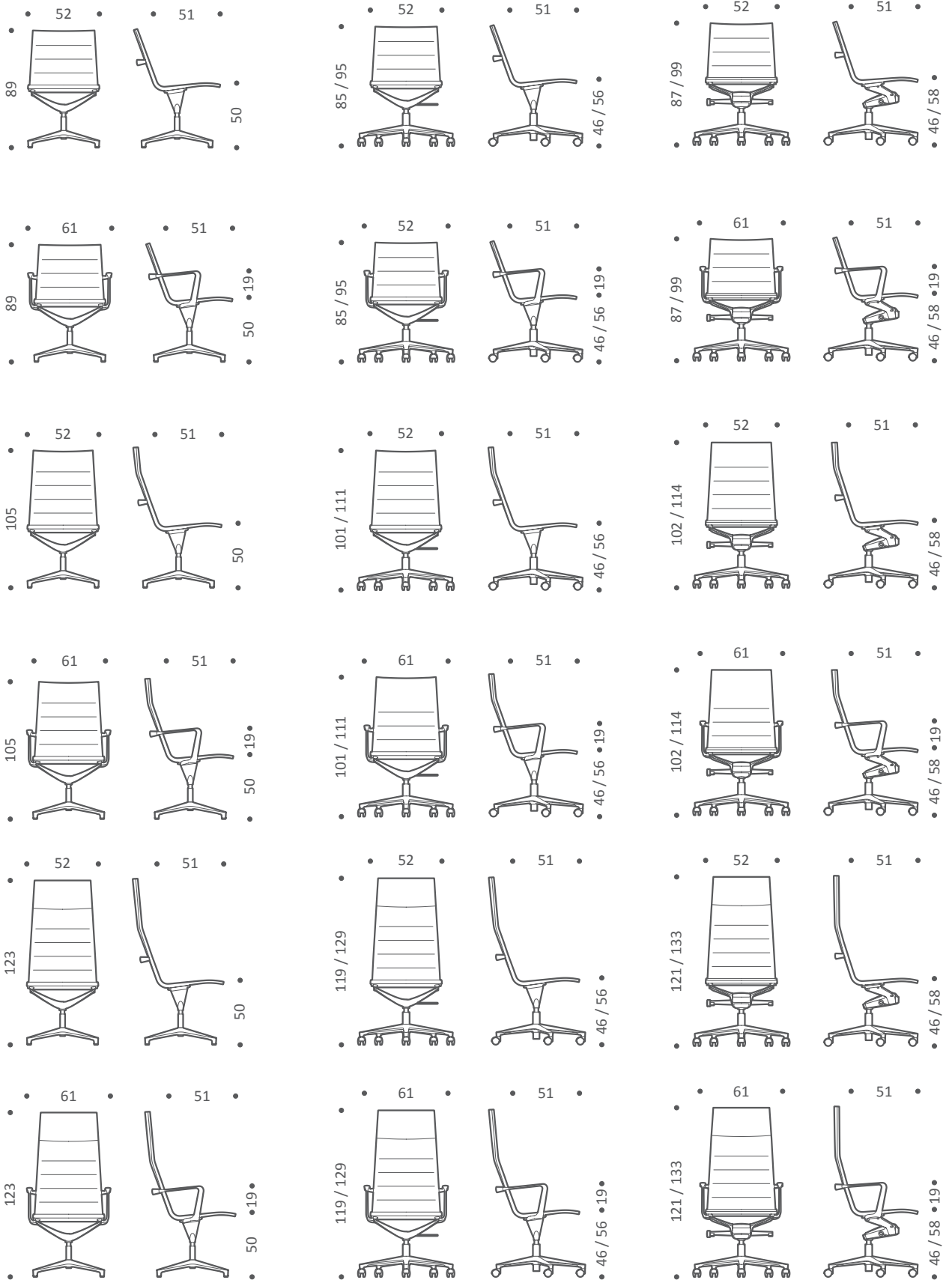

**VALEA** Esse

---



PERSONAL STYLE



VALEA ESSE has an even more contoured line that remains essential, modulated to create a lower back support that makes this version even more comfortable. Extreme comfort is guaranteed by the wide seat and its padding.

In any context where it is placed, VALEA ESSE has such a neat line that it adapts harmoniously to the space, while still adding a touch of very personal style.

COLOURFUL



The style is emphasised even more by the dry essential structure, characterised by elegant, balanced proportions. The thickness of the seat stands out in the overall look of the chair, and strengthens the character of absolute comfort of the VALEA Collection.

In either leather or fabric finish, VALEA ESSE makes colour its main feature - conveying lightness and personality to the office environment.

HIGHLIGHTS

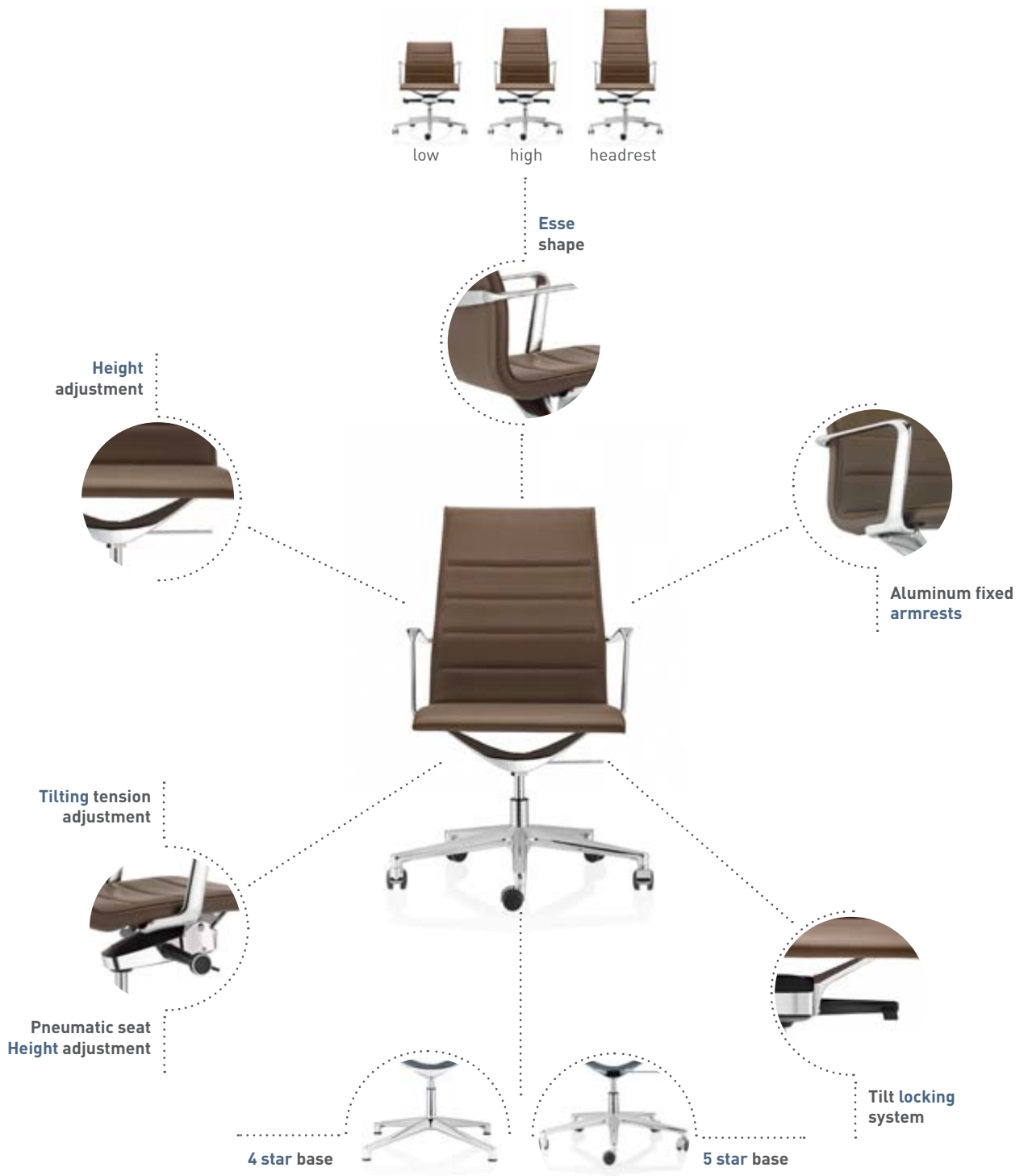

## TILTING MECHANISM

**Tilting mechanism**

Valea Chair has a simple, very effective tilting mechanism that promotes movement and provides a high level of comfort, reducing stress and strains.

The rearward seat tilting mechanism pivots from the front of the chair, so that the angle is downward motion, relieving leg stress points and allowing stability in foot position on the rearward tilt. The tilting system has an adjustable tension control according to the user's weight and is lockable in various positions.

TILTING TENSION

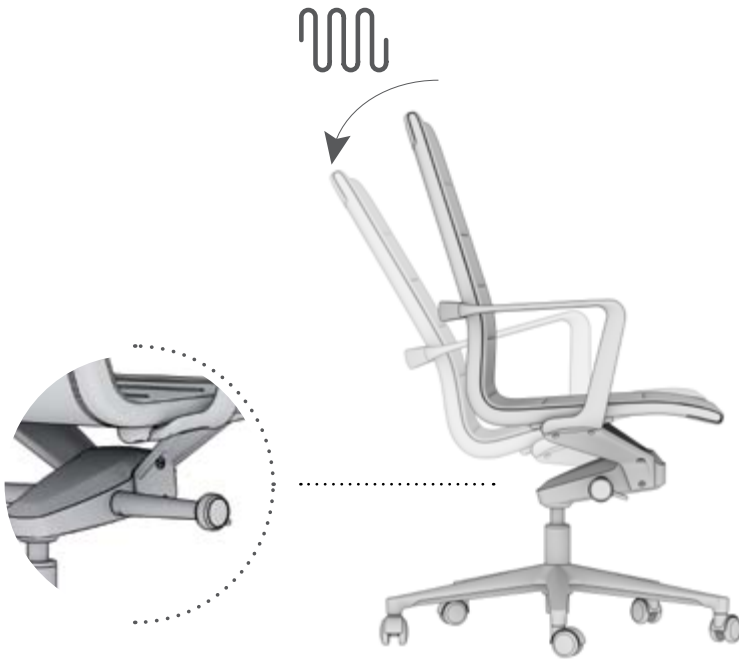

**Tilt tension**

The handle, on the right side, enables the spring tension adjustment of the tilting mechanism.

This is a function of the height and weight of an individual. The taller and/or heavier the person, the need for a tighter tilt tension. The opposite for a shorter, lighter person, the lighter the control. If the Tilt Tension is set too light for an individual, when they sit in the chair, they may have the sensation of going over backwards. Conversely, if the tension is set too tight, a smaller individual may not be able to tilt the chair at all.

TILT LOCK

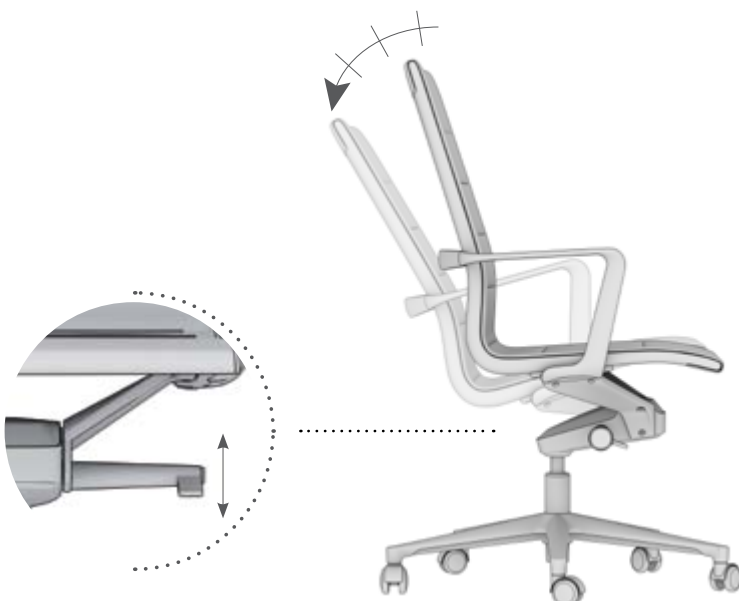

**Tilt lock**

The lever on the left side of the seat enables the user to lock/unlock the tilting mechanism in different positions.

Tilt lock allows the user to sit in an upright position for keyboarding, while providing a comfortable rocking/reclining motion during meetings, phone calls and reading activities.



HEIGHT ADJUSTMENT



**Height adjustment**

The lever on the right side enables the height adjustment of the seat. The range is 12 cm.

The 5 star base model has a height adjustment column that allows to adjust the chair individually according to different heights of users and sitting habits. The heights adjustment column allows height regulation in any position along the total stroke through internal movement of gas. It is controlled by pulling up a simple, well visible and intuitive lever.

RETURN MECHANISM

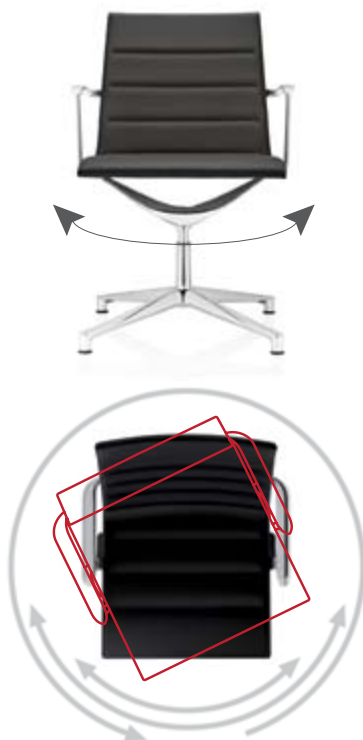

**Return mechanism**

This mechanism is standard on models with four star base, and pull the seat back to its original position.

The 4 star base has a special column that allows free-swiveling in use and that automatically rotates backrest to a frontward facing position. The fixed height column helps to keep your meeting room always in an ordinate manner.

DIMENSIONS

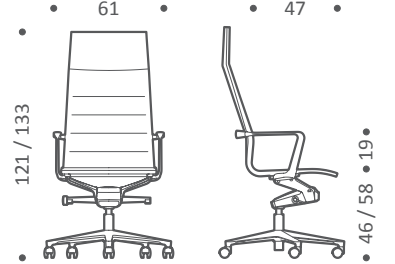
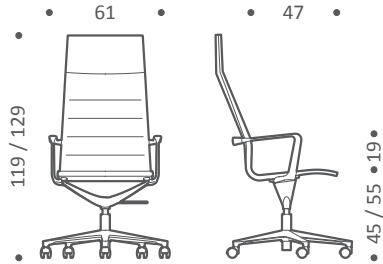
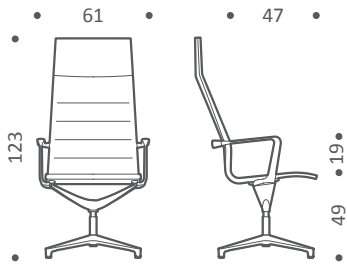
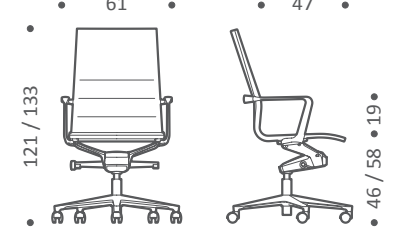
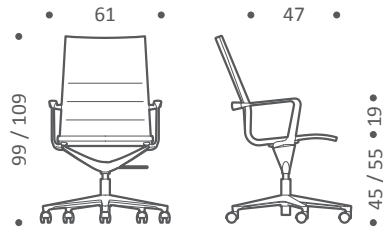
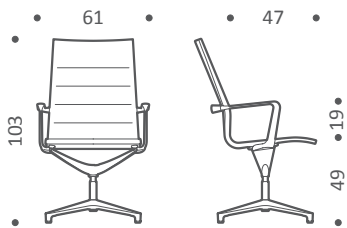
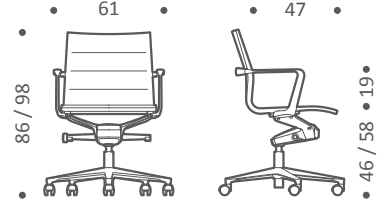
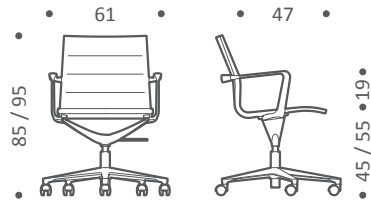
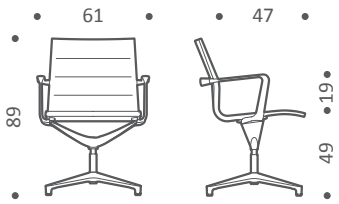

**VALEA** Lounge

---



DESIGN THAT INVITES TO RELAX



VALEA LOUNGE was created to perform its function with style and comfort. Destined mainly for waiting rooms or meeting rooms, it keeps all the characteristics of the models with taller backrests and becomes a harmonious addition to any common area. This is the strong point of the VALEA Collection: great versatility that never weakens the line's original personality.

Essential line and maximum comfort: the chair's wide seat is defined with absolute simplicity and gains impact and personality through its generous padding. Its stylistic details make it the real protagonist of this chair.

HIGHLIGHTS

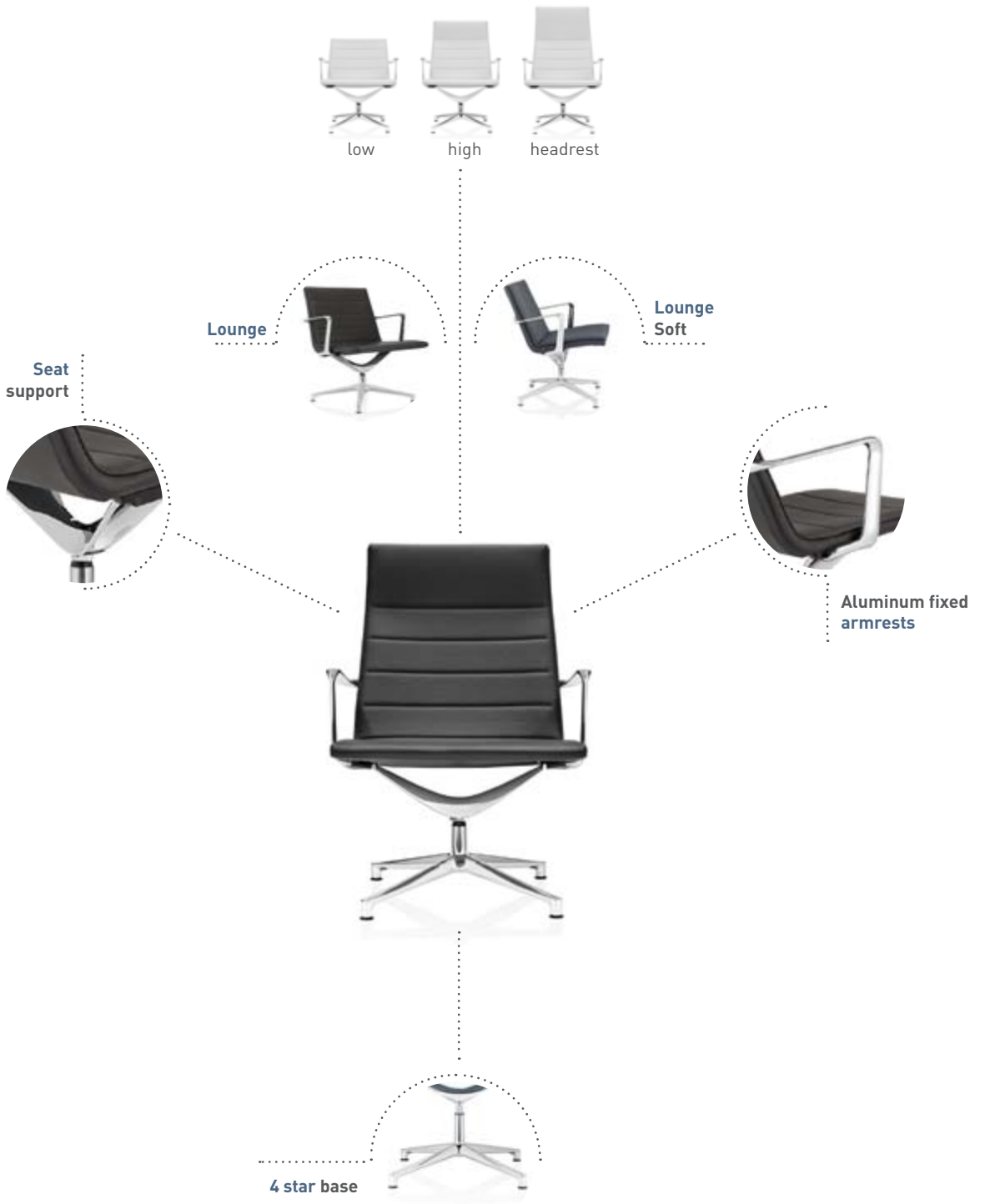

DIMENSIONS

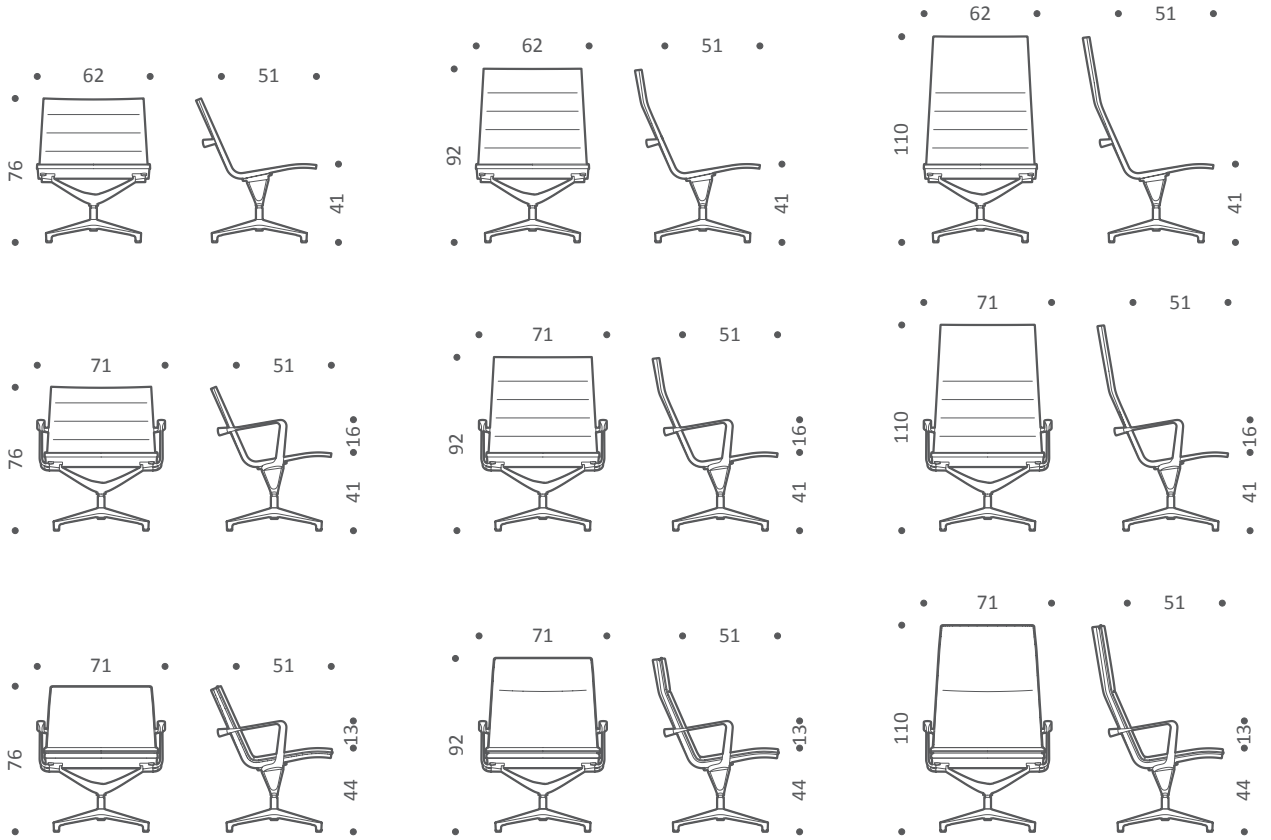

**VALEA** Cantilever



CLASSIC DESIGN, MODERN SOLUTION



The unique comfort and aesthetics of VALEA are enhanced by a traditional element: the cantilever base, a classic in the world of office chairs. The result is the new model VALEA CANTILEVER, which reflects the decisive personality of the VALEA collection with new intensity. Hints of classic design blend with functional, modern solutions to form a chair that is not only comfortable, but also particularly versatile and suitable for both operative areas and waiting or meeting rooms.

The structure is so light and clean that it seems to float in the air. The cantilever base with its extreme linearity emphasises the shape of the chair and makes it perfect for any place in the room.



HIGHLIGHTS

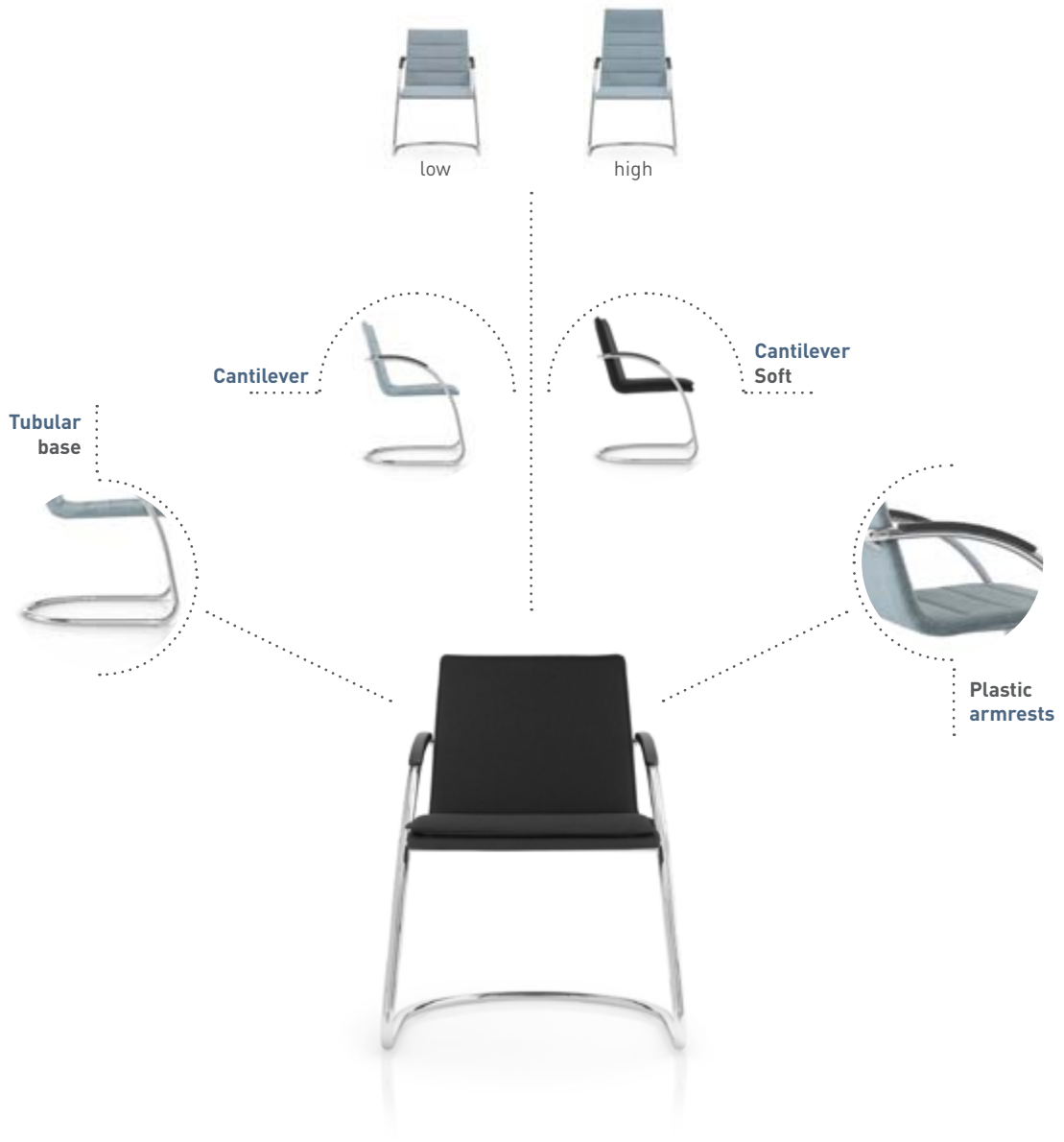

DIMENSIONS

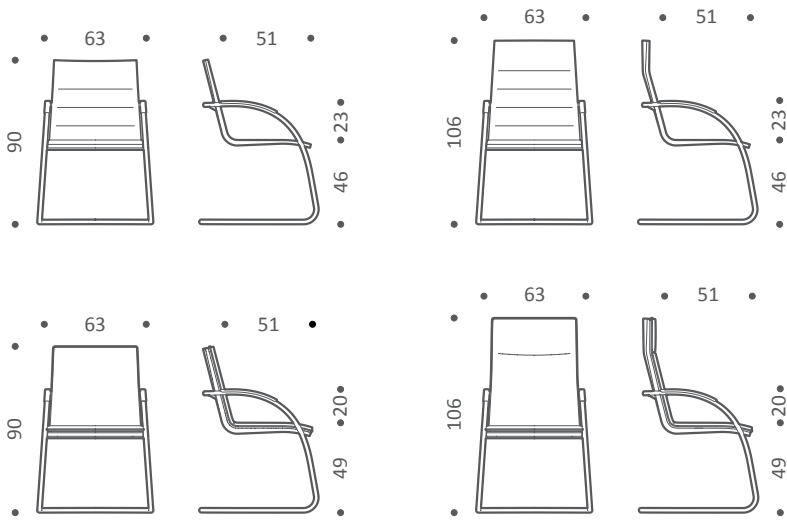

**VALEA** Soft

---



AESTHETICS & COMFORT



The perfect blend of aesthetics and comfort of the VALEA Collection finds its highest expression in VALEA SOFT. This model has another detail that ensures comfort: a padded cushion for extra back support.

In the SOFT version, VALEA's linearity appears even more accentuated to leave absolute space for comfort: the padded cushion covers the whole seat to make it the perfect place to relax.

The padding and width of the seat are so characteristic that they make VALEA the perfect synonym for comfort and ergonomics, which are conveyed in every stylistic detail.

COMFORTABLE



The padding and width of the seat are so characteristic that they make VALEA the perfect synonym for comfort and ergonomics, which are conveyed in every stylistic detail.

Vitality, comfort, lightness: VALEA SOFT has been invented to offer high level solutions in every detail.

HIGHLIGHTS

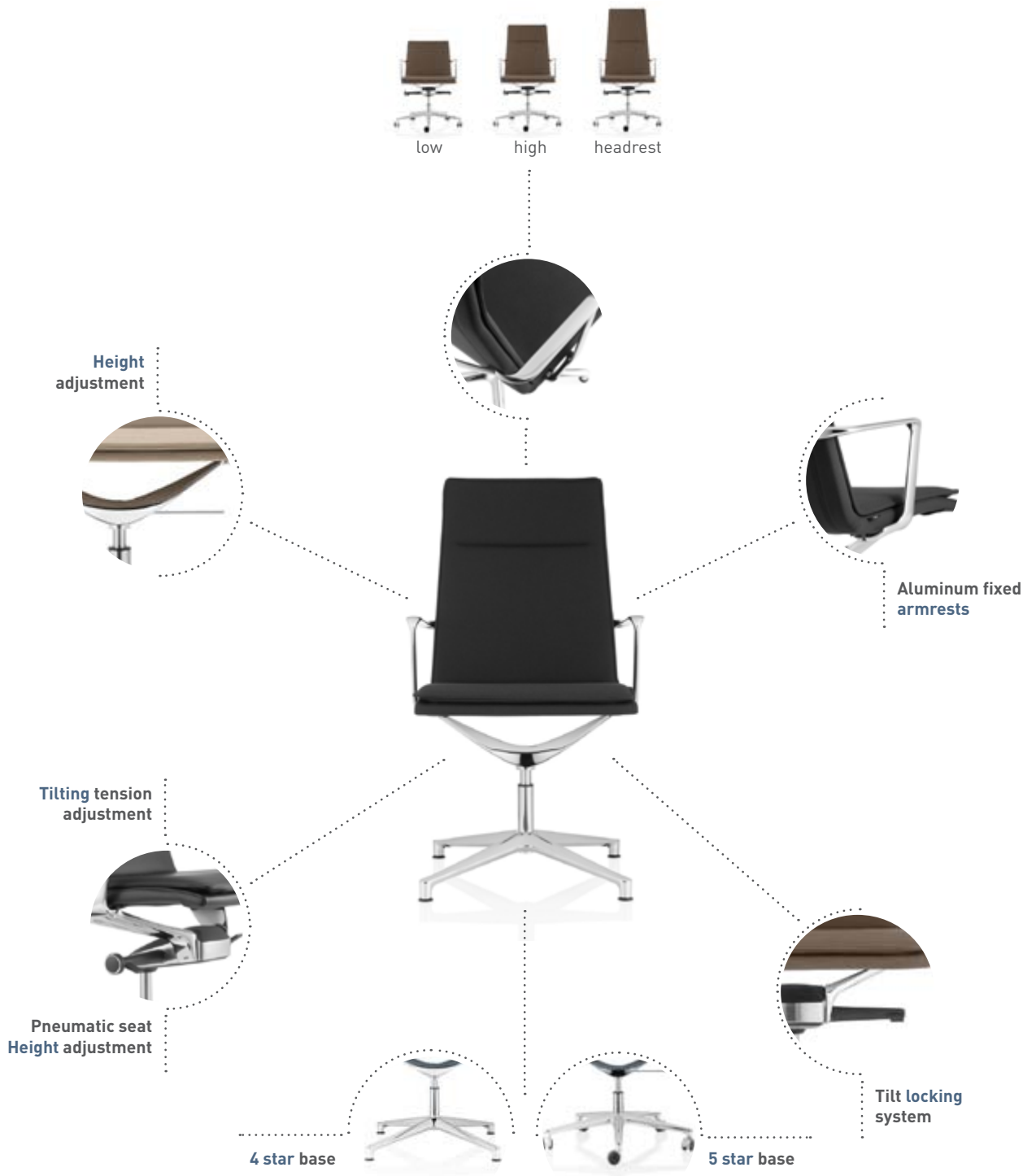

DIMENSIONS

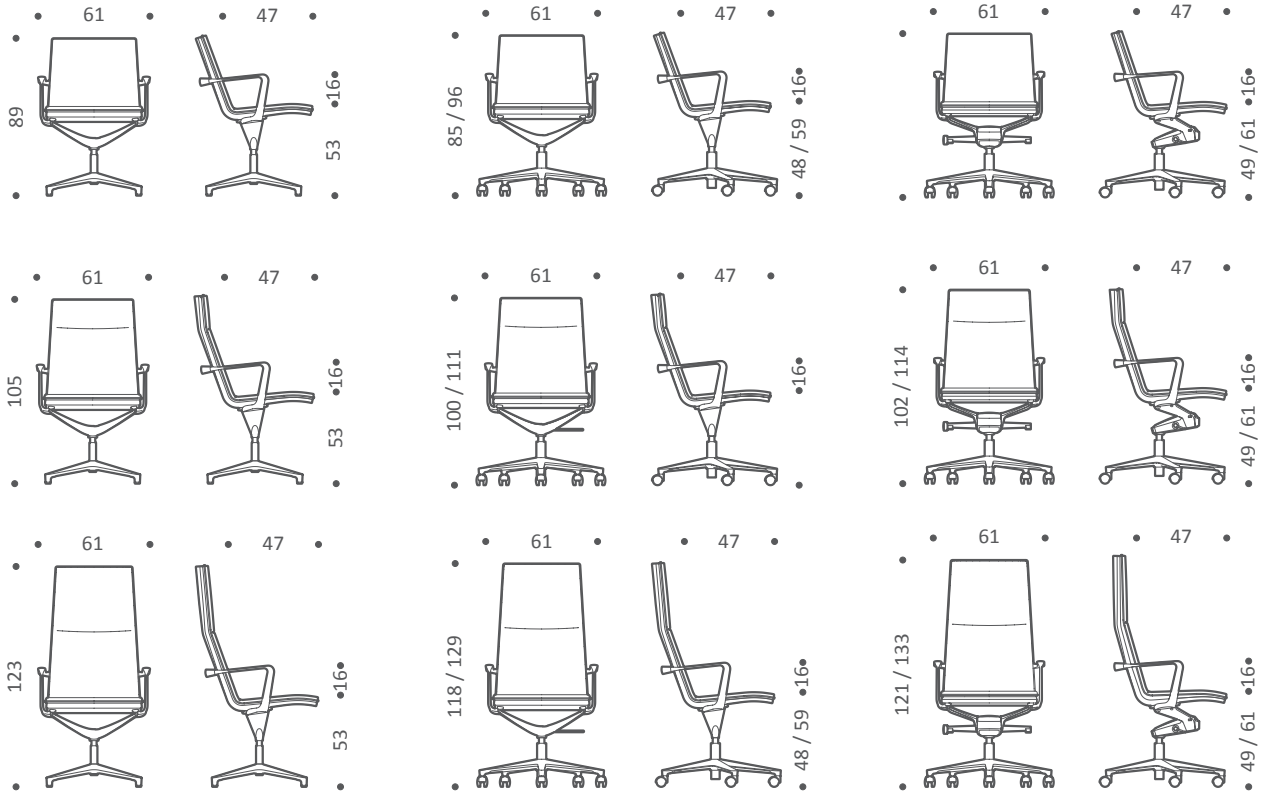

**COLOURS & FINISHES**

---





COLOURS & FINISHES

UPHOLSTERY & ALUMINIUM

<b>Cat. B</b>	Atlantic										
	Fame										
	Step										
	Step Melange										
<b>Cat. C</b>	Sotega										
	Breeze										
<b>Cat. F</b>	Fame Hybrid										
<b>Cat. E</b>	Leather										
<b>Cat. H</b>	Premium leather										

only for Soft versions





**ICF S.p.A.**

Via Cassanese, 108 - 20060 Vignate (Mi) Italy

t. +39.02.95.08.031 | f. +39.02.95.36.40.12

[www.icf-office.it](http://www.icf-office.it) | [icf@icf-office.it](mailto:icf@icf-office.it)

---