

Molteni & C

HIGH-WAVE — HANNES WETTSTEIN 2007

1—
3



Classic upholstered bed with contained proportions, embellished with vertical cord piping on the padded headboard. For the version with the mechanism, the internal part of the headboard can be tilted to provide an adjustable tabletop area. The crosspieces connecting the guides of the bed can support single or divided slatted bases, and the height of the base can be adjusted. This model is also available with a bed-base storage container. The feet are always in shiny chrome finish.

DATASHEET

REGISTERED
DESIGN

I.2015

molteni.it

Dimensions in millimeters and inches. The right to discontinue and make changes is reserved. This information is based on the latest product information available at the time of printing.

FINISHES

COVERS

fabric - leather, completely removable.

Available in fire-resistant version (TB117 and BS5852).

FEET FINISH

shiny chrome

TECHNICAL INFORMATION

STRUCTURE

Made of solid wood and multi-layered wooden panels upholstered with shaped polyurethane and cover in double-layer velveteen.

HEAD REST

Metallic framework with elastic straps upholstered with polyurethane covered in cold moulded foam. Cover in double-layer velveteen.

BASES (FOR BED-BASE STORAGE CONTAINER)

Melamine finished chipboard panelling with nylon positioning handles.

HIGH FEET

Steel structure covered with polished and varnished plastic material. Supports in antiskid plastic.

LOW FEET

Chrome-plated steel with supports in anti-skid plastic.

INTERNAL CROSSPIECES

Varnished metal.

MATTRESS-BASE SPACER

Plastic.

EXTERNAL REMOVABLE SLIPCOVERS

(See enclosed label, referring to the specific slipcover).

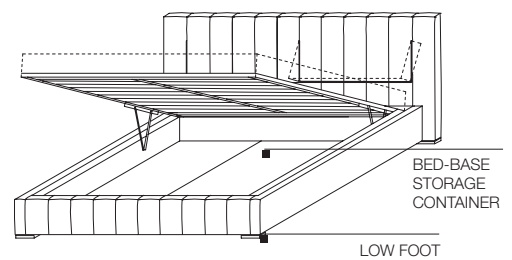
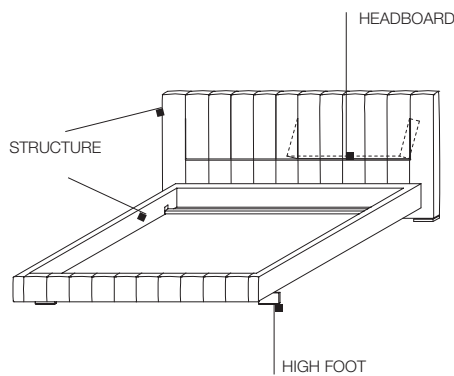

WITHOUT SPACER

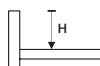

WITH SPACER (1)

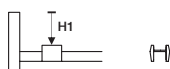

WITH SPACER (2)

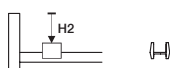

Mattress-base height adjustment

Without spacer	H	115
With spacer (1)	H1	95
With spacer (2)	H2	75

DATASHEET

REGISTERED
DESIGN

I.2015

DIMENSIONS

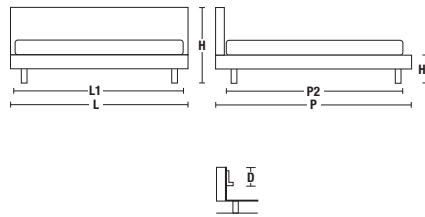

OUTER DIMENSIONS

L Width		P	H	INNER DIMENSIONS							
Bed base	Total width	Total length	Height	L1 Width	P2 Length	D Space for insertion of the slatted base					
1800	70 7/8"	2200	86 5/8"	1600	63"	1700	66 7/8"	2000	78 3/4"	75	3"
1900	74 3/4"	2100	82 3/4"	1700	66 7/8"	2100	82 3/4"	1800	70 7/8"	95	3 3/4"
2000	78 3/4"	2200	86 5/8"	KS1950	76 3/4"	2050	80 3/4"	2300	90 1/2"	115	4 1/2"
KS2150	84 5/8"	KS2350	92 1/2"	for KS		for KS		310	12 1/4"		

Depth of 2100 mm (82 3/4") (inner measurement) is also available on HW16-HW17-HW18. Depth 2100 mm (inner measurement) is not available for beds with container under the slatted base.

Molteni & C

bed taking a single slatted base or 2 individual slatted bases

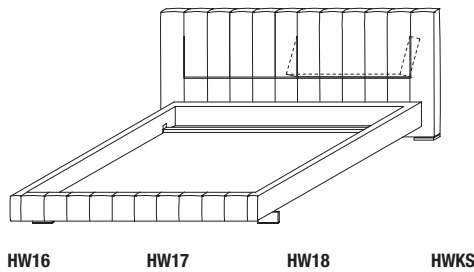

double bed with tilting slatted base and container under the slatted base

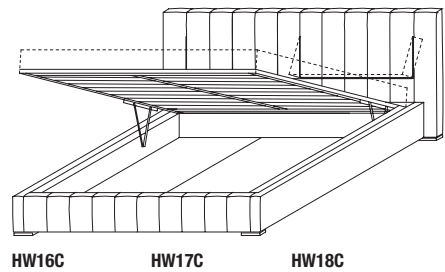

bed taking a single slatted base or 2 individual slatted bases

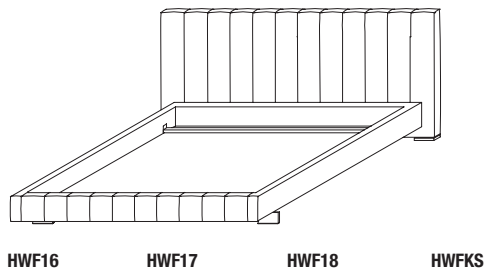

double bed with tilting slatted base and container under the slatted base

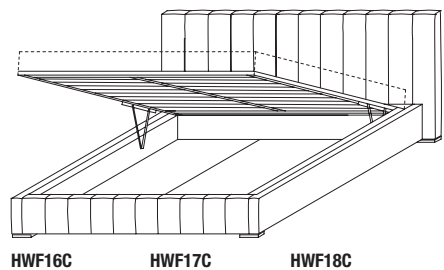

DATASHEET

REGISTERED
DESIGN

I.2015