

Molteni & C

909 — LUCA MEDA 1991

1—
4



Flexible system of drawer units with pressure-opening or opening with handle enriched by an elegant open compartment in shiny aluminum and matt etched glass. 909 is available in the finishes matt lacquered (with the option of glossy lacquered drawer fronts to match the matt lacquered structure), open grain lacquered or glossy lacquered.

DATASHEET

REGISTERED
DESIGN

I.2015

molteni.it

Dimensions in millimeters and inches. The right to discontinue and make changes is reserved. This information is based on the latest product information available at the time of printing.

FINISHES

STRUCTURE FINISHES

matt lacquer colours in the Molteni colour range - open grain lacquer colours in the Molteni colour range

DRAWER FINISHES

matt lacquer colours in the Molteni colour range - open grain lacquer colours in the Molteni colour range - glossy lacquer colours in the Molteni colour range

TOP FINISHES

matt lacquer colours in the Molteni colour range - open grain lacquer colours in the Molteni colour range - glossy lacquer colours in the Molteni colour range - grey oak - black oak - light elm - dark elm - coloured glass in the Molteni colour range - etched coloured glass in the Molteni colour range

HANDLE AND INSERT OF THE PRESSURE-OPENING DOORS FINISH

shiny chrome

LEGS FINISHES

black - shiny chrome

TECHNICAL INFORMATION

STRUCTURE AND FRONT

Wood particleboard with melamine facing painted in the colours available in the “Molteni Range”.

SIDES AND INTERNAL DRAWER BOTTOM

Particleboard panel, coated with melamine resin.

HANDLE

In chrome plated metal.

OPEN COMPARTMENT

Frame in extruded anodised aluminium with tempered coloured etched glass (th.4mm). Adjustable metallic feet.

GLASS TOP

Glass (th. 10mm), tempered coloured extralight or etched and coloured in the colours available in the “Molteni Range”.

WOODEN TOP

MDF panel veneered with wood – Oak (Quercus), Elm (Ulmus rubra) – or faced with melamine painted in the “Molteni Range” colours.

ADJUSTABLE FEET

Non-skid plastic material.

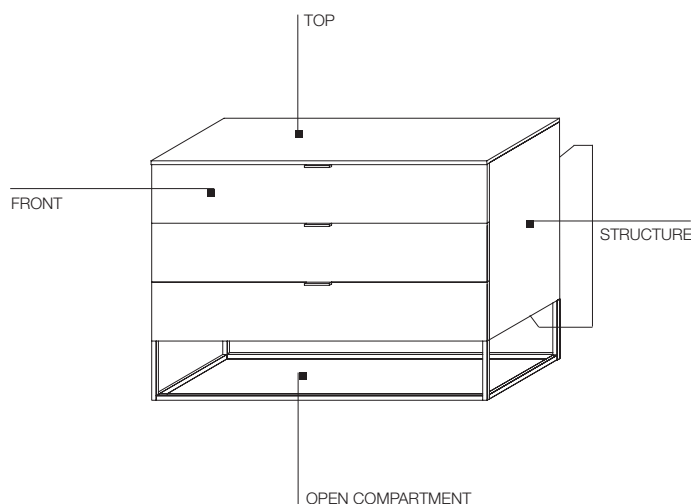

DATASHEET

REGISTERED
DESIGN

I.2015

DIMENSIONS

Notes

- The finishing top is compulsory.
- Standard version comes with partially extractable runners.
- Fully extractable runners on request.

drawer unit with 1 drawer

W 480 D 480 H 342
W 18 7/8" D 18 7/8" H 13 1/2"



handle
NCM4/16

pressure-opening
NCP4/16

drawer unit with 1 drawer

W 960 D 480 H 342
W 37 3/4" D 18 7/8" H 13 1/2"



handle
NCM9/16

pressure-opening
NCP9/16

drawer unit with 2 drawers

W 480 D 480 H 340
W 18 7/8" D 18 7/8" H 13 3/8"



handle
NTM4/32

pressure-opening
NTP4/32

drawer unit with 2 drawers

W 480 D 480 H 502
W 18 7/8" D 18 7/8" H 19 3/4"



handle
NCM4/32

pressure-opening
NCP4/32

drawer unit with 2 drawers

W 960 D 480 H 340
W 37 3/4" D 18 7/8" H 13 3/8"

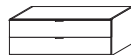

handle
NTM9/32

pressure-opening
NTP9/32

drawer unit with 2 drawers

W 960 D 480 H 502
W 37 3/4" D 18 7/8" H 19 3/4"



handle
NCM9/32

pressure-opening
NCP9/32

drawer unit with 3 drawers

W 480 D 480 H 500
W 18 7/8" D 18 7/8" H 19 3/4"



handle
NTM4/48

pressure-opening
NTP4/48

drawer unit with 3 drawers

W 480 D 480 H 662
W 18 7/8" D 18 7/8" H 26"



handle
NCM4/48

pressure-opening
NCP4/48

drawer unit with 3 drawers

W 960 D 480 H 500
W 37 3/4" D 18 7/8" H 19 3/4"



handle
NTM9/48

pressure-opening
NTP9/48

drawer unit with 3 drawers

W 960 D 480 H 662
W 37 3/4" D 18 7/8" H 26"



handle
NCM9/48

pressure-opening
NCP9/48

DIMENSIONS

drawer unit with 3 drawers

W 960 D 480 H 660
W 37 3/4" D 18 7/8" H 26"

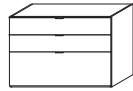

handle
NTM9/64/3 pressure-opening
NTP9/64/3

drawer unit with 3 drawers

W 960 D 480 H 822
W 37 3/4" D 18 7/8" H 32 3/8"

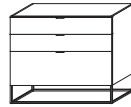

handle
NCM9/64/3 pressure-opening
NCP9/64/3

drawer unit with 4 drawers

W 960 D 480 H 660
W 37 3/4" D 18 7/8" H 26"

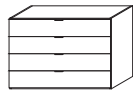

handle
NTM9/64/4 pressure-opening
NTP9/64/4

drawer unit with 4 drawers

W 960 D 480 H 822
W 37 3/4" D 18 7/8" H 32 3/8"

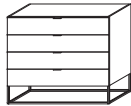

handle
NCM9/64/4 pressure-opening
NCP9/64/4

drawer unit with 5 drawers

W 480 D 480 H 980
W 18 7/8" D 18 7/8" H 38 5/8"



handle
NTM4/96 pressure-opening
NTP4/96

drawer unit with 5 drawers

W 960 D 480 H 980
W 37 3/4" D 18 7/8" H 38 5/8"

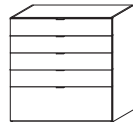

handle
NTM9/96 pressure-opening
NTP9/96

led lighting system
for open compartment

finishing tops

D 484 th 10
D 19" th 3/8"



TOQ48

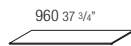

TOQ96

for W 480 18 7/8"



HLG48

for W 960 37 3/4"

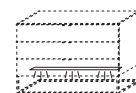

HLG96

FINISHES

	MATT LACQUER/ OPEN GRAIN LACQUER	GLOSSY LACQUER	COLOURED GLASS	ETCHED COLOURED GLASS
CHALK WHITE	•	•	•	•
IVORY	•			
PEARL	•	•	•	•
SILICA	•	•	•	•
SAND	•	•	•	•
PLATINUM	•	•	•	•
DUNE	•	•	•	•
CLAY	•	•	•	•
DOLOMITE GREY	•	•	•	•
BORDEAUX	•	•	•	•
MOKA	•	•	•	•
ORANGE	•	•	•	•
MUSTARD	•	•	•	•
CARAMEL	•	•	•	•
LIGHT BLUE GREY	•	•	•	•
AQUAMARINE	•	•	•	•
VENETIAN RED	•	•	•	•
LEAD	•	•	•	•
ANTHRACITE	•	•	•	•
BLACK	•	•	•	•
LESSLESS RED	•			
	only matt lacquer			

FINISHES

WOODS

EUCALYPTUS



AMERICAN WALNUT

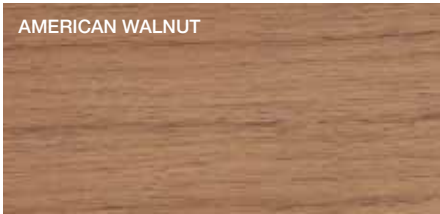

GREY OAK



BLACK OAK

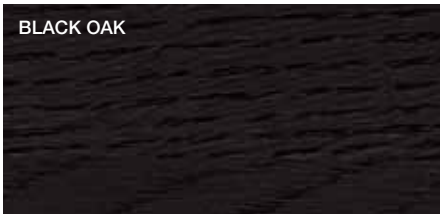

DARK ELM



LIGHT ELM

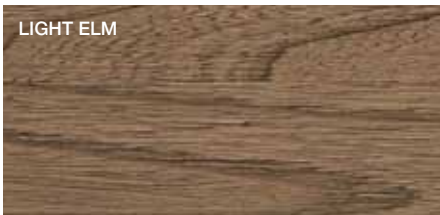

CEDAR



MARBLES

WHITE CARRARA MARBLE



CALACATTA MARBLE



RED FRENCH MARBLE

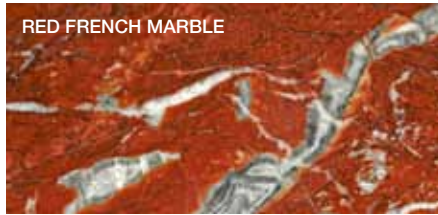

EMPERADOR DARK MARBLE



CARNIAN GREY MARBLE

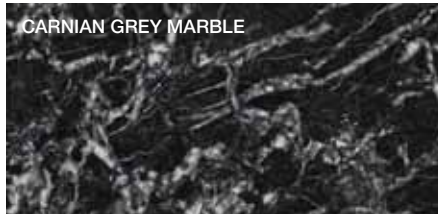

ABSOLUTE BLACK GRANITE



GRES

WHITE GRES

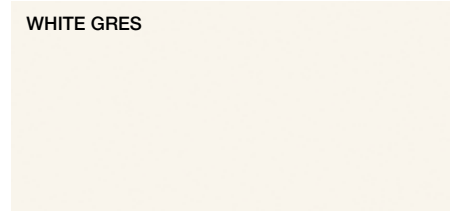

ANTHRACITE GRES



METAL PARTS

BLACK CHROME

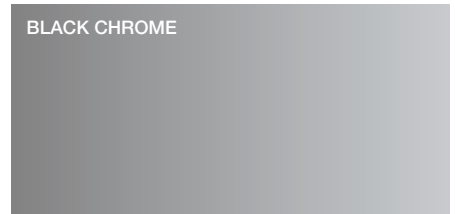

SHINY ALUMINIUM



PEWTER COLOUR

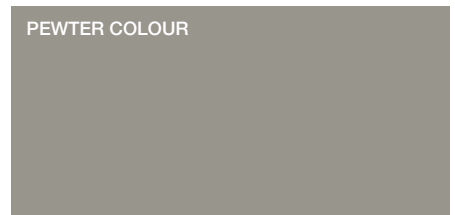

MILLERIGHE
GLISS QUICK FRONT



MILLERIGHE
GLISS QUICK, GLISS 5TH STRUCTURE



DWELL
DOOR FRAME, TRACK COVERING PROFILES

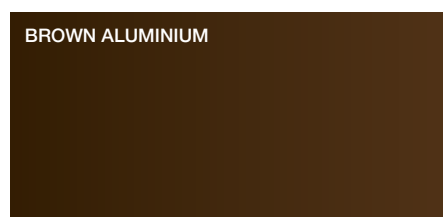
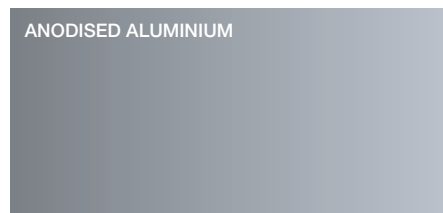

CARTAPAGLIA
GLISS QUICK, GLISS WALK-IN FRONT

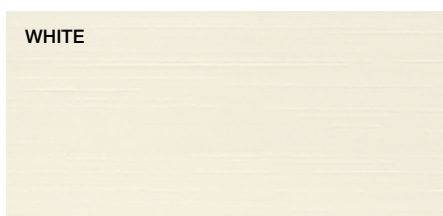

Millerighe dark finish available also for Gliss Walk-In where specifically indicated in the pricelist