

2008-2012



Armrest with a top stitched seam



A system of sofas and sectionals.

Frame

Sofas and sectionals with a frame in solid wood and elastic belts.

Concealed feet.

Filling in non-deformable variable density polyether and down or in polyester wadding. The polyester wadding version is more rigid and costs less whilst maintaining the same level of comfort and quality.

Pull-out elements: with the 95 cm large intermediate element and the 119 cm large end element with armrest, a sliding system allows to increase the seat depth by 18 cm for a better comfort.

To pull out the seat, slide it out smoothly.

NB: No element can be used as a single element.

Cover

The upholstery covers every part of the sofa and is completely removable.

The new top stitched seam highlights the arms in the end /corner and special units.

The underlining in cotton makes removing the cover easier and the product maintains its good looks even when uncovered.

Optional extra covers if required.

All units in leather may have, at MDF Italia's discretion, one or more seams.

For the choice of upholstery, please see the section "fabric collection" on the website.

With customer's own leather, in order that the product is properly manufactured, the leather piece must be larger than 5 sqm and with no defects, such as scars or holes.

Accessories

With sectionals, a coupling device is provided. This request must be highlighted by a drawing.

FLAME RETARDANT PADDING

Norms 1IM, California TB 117-2013 and BS are available upon request with a surcharge as of +5%. Feasibility, costs and delivery times to be verified with our Sales Dept.

NB: the use of flame retardant polyurethanes and interliner can give a different result from the standard.

PULL-OUT INTERMEDIATE AND END UNITS



SOFAS

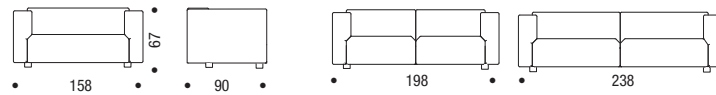

CORNER UNITS

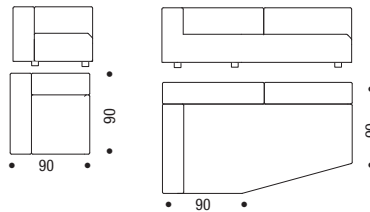

INTERMEDIATE UNITS

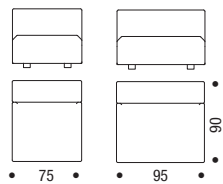

PULL-OUT INTERMEDIATE UNITS

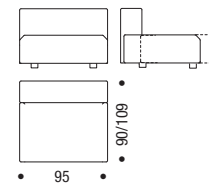

END UNITS

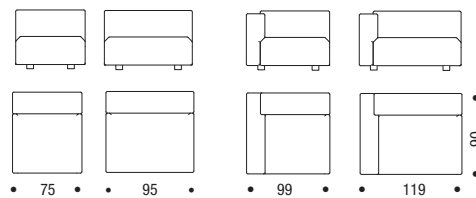

PULL-OUT END UNITS

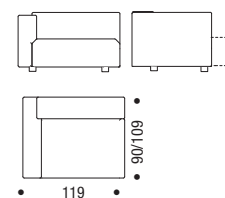

SPECIAL END UNITS

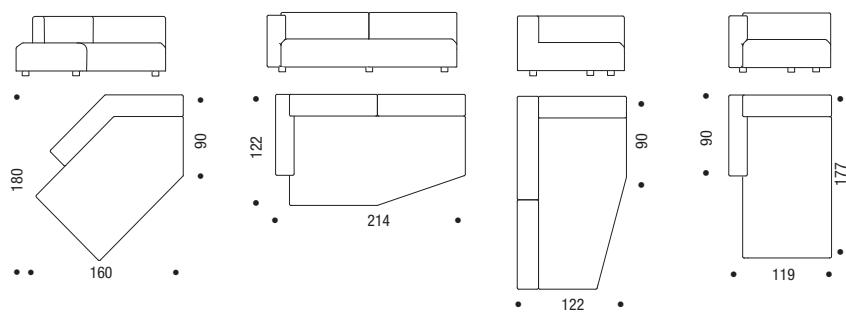

POUF

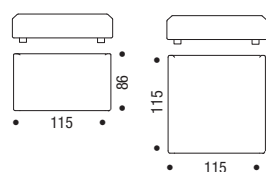

CUSHIONS



Loose cushions

In solid colour with down filling covered with cotton. This makes removing the cover easier and the cushions maintain their good looks even when uncovered.

Extra covers available.

Dims: 30x50 cm, 40x40 cm or 50x50 cm

FLAME RETARDANT PADDING

Norms 1IM, California TB 117-2013 and BS are available upon request with a surcharge as of +5%. Feasibility, costs and delivery times to be verified with our Sales Dept.

NB: the use of flame retardant polyurethanes and interliner can give a different result from the standard.