



' vol. 1 SOFAS AND SEATING SYSTEMS

**SOFAS and SEATING ELEMENTS for COMPOSITIONS**  
 Injected flame-retardant polyurethane foam and polyester fiber over internal steel frame.

Front-back to-leg base is tubular steel with chrome or varnished steel powder coat finish.

Seat cushions are in goose down over polyurethane foam.

Back, armrest and optional cushions are goose down.

The Gentry collection covers are removable.

**NOTES:**

- sofas include two armrest cushions, elements with an arm include one armrest cushion
- compositions drawings are of right-facing versions only
- custom compositions: drawing must accompany order

**caution:** leather covers have stitched seams on back and armrests: other fabric versions do not have stitched seams. Back and optional cushions: backside of the covers in leather T will be in fabric (felt) matching the color of the leather.

Design **Patricia Urquiola** - 2011



**Recommended fabric hangers**

**Tirelle e tessuti consigliati**

115-People for Gentry

118-Units 1

119-Units 2 **art.351 art.356**

120-Units 3 **art.338**

123-Units 4 **velours cin cin**

124-Units 5 **velours cin cin**

121-Elastic Fantastic 1 by Febrik

-Husk

-Pelle Cirè - Leather Cirè Z

**Feet colors - Colori piedi**



natural steel  
chrome



black steel  
chrome



RAL 3009  
oxidored

' vol. 1 DIVANI E SISTEMI DI SEDUTE

**DIVANI ed ELEMENTI DI SEDUTA per COMPOSIZIONI**  
 Espanso schiumato a freddo ignifugo e fibra poliestere con struttura interna in acciaio. Piedi a ponte in tubo di acciaio cromato o verniciato a polveri.

I cuscini della seduta sono in piuma d'oca con inserto in poliuretano espanso. I cuscini dello schienale, del bracciolo e quelli opzionali sono in piuma d'oca.

La collezione Gentry è sfoderabile.

**NOTE:**

- i divani includono due cuscini per bracciolo; gli elementi con un bracciolo includono un cuscino per bracciolo
- tutti i disegni delle composizioni si riferiscono alla versione destra
- allegare un disegno per ogni ordine di composizione non codificata

**avvertenze:** i rivestimenti in pelle hanno cuciture di giuntura sul retro e sui braccioli mentre le versioni in tessuto non hanno cuciture. Cuscini schienale e optional: per il rivestimento in pelle T, la parte posteriore dei cuscini viene rivestita in tessuto (panno) in abbinamento al colore della pelle scelta.

## Sofa

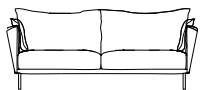

855-856

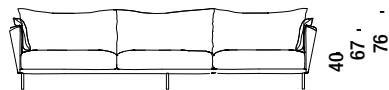

857

214-772



90

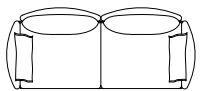

002-018

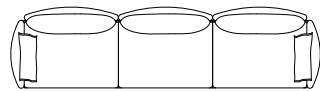

617



017

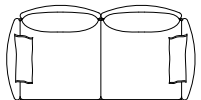

598-599

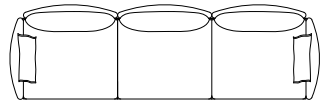

300



076

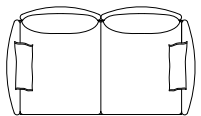

210-240

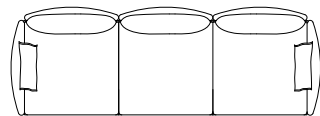

300



077

## Example of composition

composition B80Dx-B80Sx

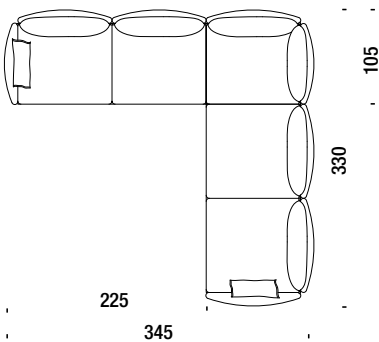

composition 628+883

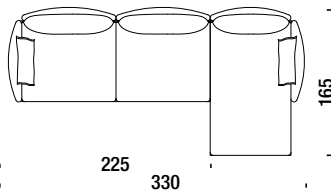

## Armchair 120x90

Poltrona 120x90

001

8,2 mt. ★ 13,2 m<sup>2</sup> 0,9 m<sup>3</sup> 50 Kg

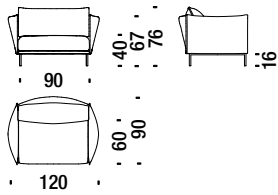

## Armchair 135x90

Poltrona 135x90

004

9 mt. ★ 15,4 m<sup>2</sup> 1 m<sup>3</sup> 60 Kg

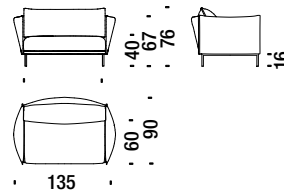

## Sofa 180x90

Divano 2 posti 180x90

886

12 mt. ★ 22,8 m<sup>2</sup> 1,4 m<sup>3</sup> 68 Kg

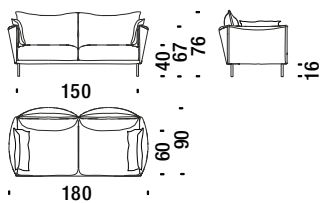

## 2 seater sofa 210x90

Divano 2 posti 210x90

855

13 mt. ★ 24,7 m<sup>2</sup> 1,5 m<sup>3</sup> 87 Kg

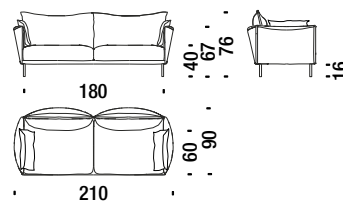

## 2 seater sofa major 240x90

Divano 2 posti major 240x90

856

13,5 mt. ★ 25,7 m<sup>2</sup> 1,7 m<sup>3</sup> 92 Kg

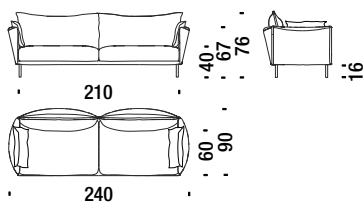

## 3 seater sofa 300x90

Divano 3 posti 300x90

857

16,5 mt. ★ 31,3 m<sup>2</sup> 2,2 m<sup>3</sup> 110 Kg

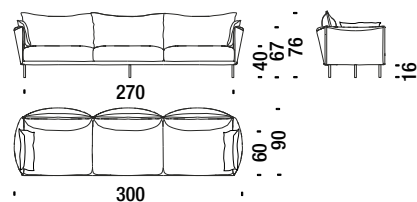

## Composition C71R or C71L

Composizione C71Dx-C71Sx

C71

17 mt. ★ 32,3 m<sup>2</sup> 2,2 m<sup>3</sup> 123 Kg

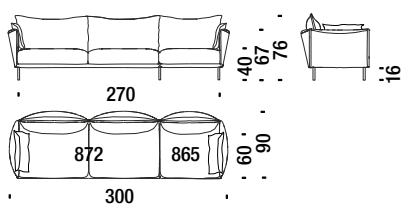

## Composition C81R or C81L

Composizione C81Dx-C81Sx

C81

18,2 mt. ★ 35 m<sup>2</sup> 2,5 m<sup>3</sup> 120 Kg

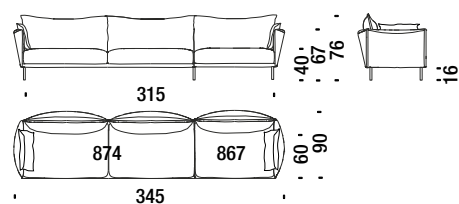

## Sofa 180x105

Divano 2 posti 180x105

887

12,8 mt. ★ 24,3 m<sup>2</sup> 1,4 m<sup>3</sup> 88 Kg

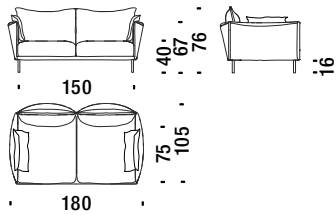

## 2 seater sofa 210x105

Divano 2 posti 210x105

002

12,8 mt. ★ 24,3 m<sup>2</sup> 1,7 m<sup>3</sup> 91 Kg

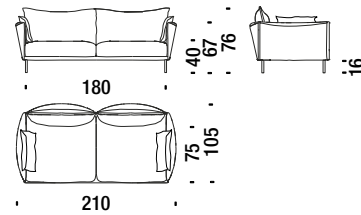

## 2 seater sofa major 240x105

Divano 2 posti major 240x105

018

13,2 mt. ★ 25 m<sup>2</sup> 2,1 m<sup>3</sup> 106 Kg

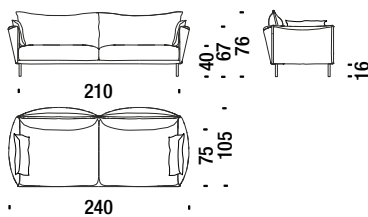

## 3 seater sofa 300x105

Divano 3 posti 300x105

617

17 mt. ★ 32,3 m<sup>2</sup> 2,5 m<sup>3</sup> 130 Kg

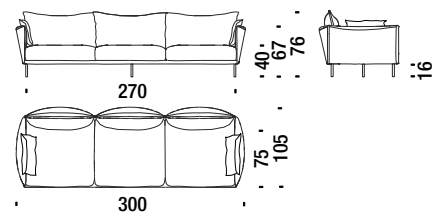

## Composition C30R or C30L

Composizione C30Dx-C30Sx

C30

17,7 mt. ★ 34 m<sup>2</sup> 2,4 m<sup>3</sup> 130 Kg

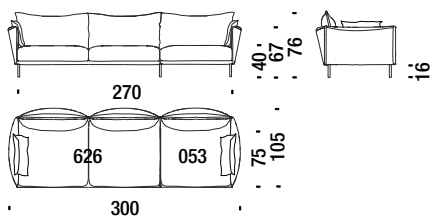

## Composition C60R or C60L

Composizione C60Dx-C60Sx

672

18 mt. ★ 34,5 m<sup>2</sup> 2,8 m<sup>3</sup> 152 Kg

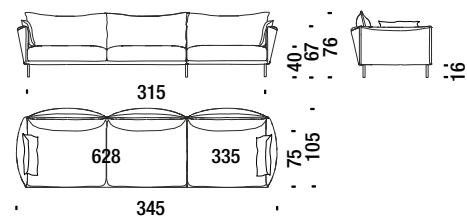

## 2 seater sofa 210x120

Divano 2 posti 210x120

598

13,2 mt. ★ 25 m<sup>2</sup> 1,9 m<sup>3</sup> 103 Kg

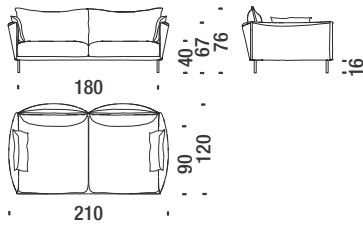

## 2 seater sofa major 240x120

Divano 2 posti major 240x120

599

13,5 mt. ★ 25,7 m<sup>2</sup> 2,1 m<sup>3</sup> 113 Kg

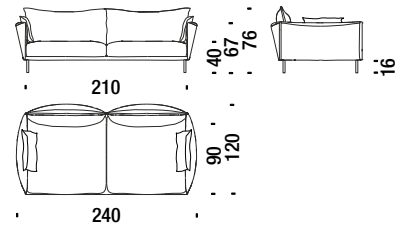

## 3 seater sofa 300x120

Divano 3 posti 300x120

618

17,6 mt. ★ 33,5 m<sup>2</sup> 2,7 m<sup>3</sup> 130 Kg

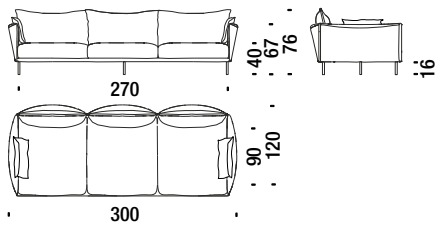

## Composition C40R or C40L

Composizione C40Dx-C40Sx

C40

17,5 mt. ★ 33 m<sup>2</sup> 2,7 m<sup>3</sup> 120 Kg

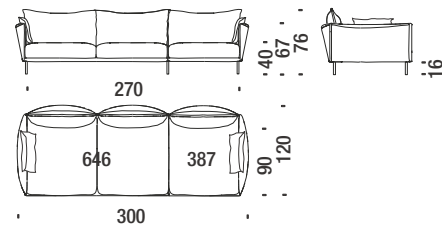

## Composition C70R or C70L

Composizione C70Dx-C70Sx

673

19,3 mt. ★ 37 m<sup>2</sup> 3 m<sup>3</sup> 140 Kg

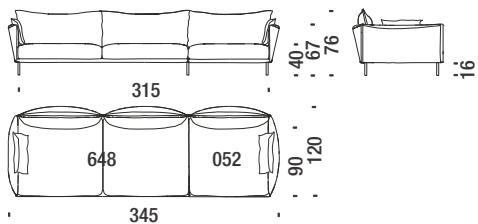

## Stool 90x75

### Pouf 90x75

214

2,5 mt. ★ 4,9 m<sup>2</sup> 0,3 m<sup>3</sup> 28 Kg

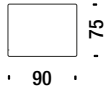

## Stool 90x90

### Pouf 90x90

017

2,8 mt. ★ 5,2 m<sup>2</sup> 0,4 m<sup>3</sup> 25 Kg

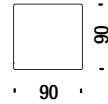

## Stool 105x75

### Pouf 105x75

772

3,1 mt. ★ 5,5 m<sup>2</sup> 0,4 m<sup>3</sup> 25 Kg

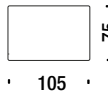
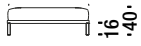

## Stool 105x90

### Pouf 105x90

076

3,2 mt. ★ 6 m<sup>2</sup> 0,6 m<sup>3</sup> 40 Kg

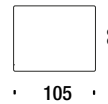
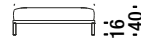

## Stool 105x105

### Pouf 105x105

077

4 mt. ★ 7,3 m<sup>2</sup> 0,7 m<sup>3</sup> 35 Kg

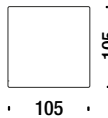

## Optional cushion 45x40

### Cuscino optional 45x40

04K

0,6 mt. ★ 1 m<sup>2</sup>



## Optional cushion 58x28

### Cuscino optional 58x28

529

0,7 mt. ★ 1,1 m<sup>2</sup>



## Optional cushion 58x52

### Cuscino optional 58x52

531

0,8 mt. ★ 1,2 m<sup>2</sup>



## 1 seater central element 90x90

**Elemento 1p centrale 90x90**

858

4,8 mt. ★ 9,1 m<sup>2</sup> 0,7 m<sup>3</sup> 30 Kg

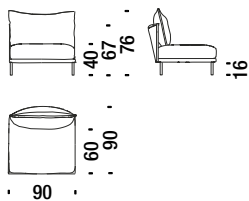

## 1 seater central element 105x90

**Elemento 1p centrale 105x90**

859

5,4 mt. ★ 10,2 m<sup>2</sup> 0,9 m<sup>3</sup> 35 Kg

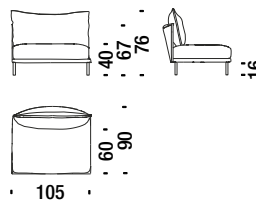

## 1 seater lateral left 105x90

**Elemento 1p sinistro 105x90**

864

6,8 mt. ★ 13 m<sup>2</sup> 0,8 m<sup>3</sup> 45 Kg

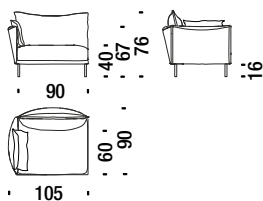

## 1 seater lateral right 105x90

**Elemento 1p destro 105x90**

865

6,8 mt. ★ 13 m<sup>2</sup> 0,8 m<sup>3</sup> 45 Kg

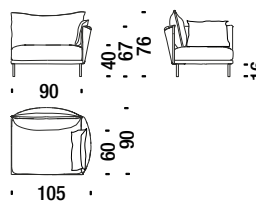

## 1 seater lateral left 120x90

**Elemento 1p sinistro 120x90**

866

7 mt. ★ 13,3 m<sup>2</sup> 0,9 m<sup>3</sup> 40 Kg

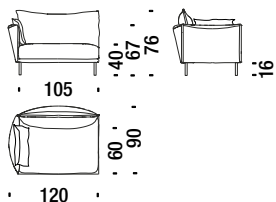

## 1 seater lateral right 120x90

**Elemento 1p destro 120x90**

867

7 mt. ★ 13,3 m<sup>2</sup> 0,9 m<sup>3</sup> 40 Kg

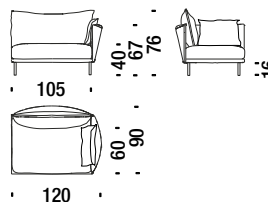

## 1 seater lateral element 90x90

**Elemento 1p laterale 90x90**

09U

6 mt. ★ 11 m<sup>2</sup> 0,7 m<sup>3</sup> 35 Kg

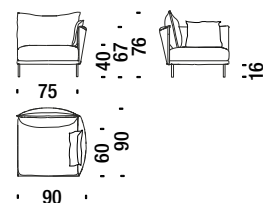

## 2 seater central element 150x90

### Elemento 2p centrale 150x90

860

8,4 mt. ★ 16 m<sup>2</sup> 1,1 m<sup>3</sup> 50 Kg

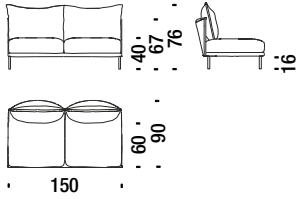

## 2 seater central element 180x90

### Elemento 2p centrale 180x90

862

8,8 mt. ★ 16,8 m<sup>2</sup> 1,3 m<sup>3</sup> 60 Kg

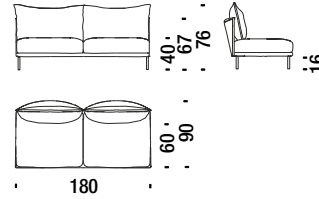

## 2 seater central element 210x90

### Elemento 2p centrale 210x90

863

9,6 mt. ★ 18,2 m<sup>2</sup> 1,5 m<sup>3</sup> 65 Kg

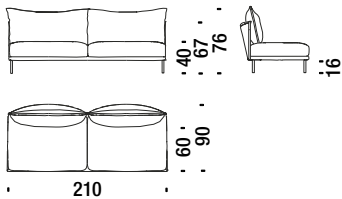

## 2 seater lateral left 165x90

### Elemento 2p sinistro 165x90

868

11 mt. ★ 21 m<sup>2</sup> 1,2 m<sup>3</sup> 55 Kg

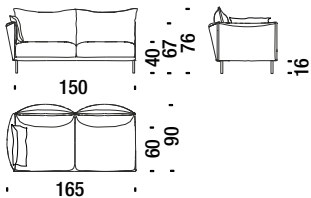

## 2 seater lateral right 165x90

### Elemento 2p destro 165x90

869

11 mt. ★ 21 m<sup>2</sup> 1,2 m<sup>3</sup> 55 Kg

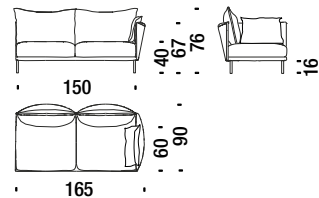

## 2 seater lateral left 195x90

### Elemento 2p sinistro 195x90

872

11 mt. ★ 21 m<sup>2</sup> 1,4 m<sup>3</sup> 78 Kg

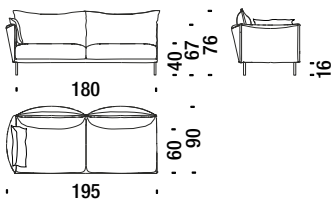

## 2 seater lateral right 195x90

### Elemento 2p destro 195x90

873

11 mt. ★ 21 m<sup>2</sup> 1,4 m<sup>3</sup> 78 Kg

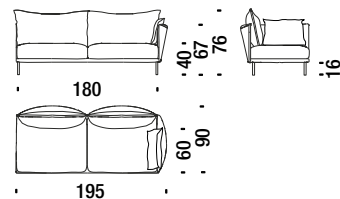



## 2 seater lateral left 225x90

### Elemento 2p sinistro 225x90

874

11 mt. ★ 22,5 m<sup>2</sup> 1,6 m<sup>3</sup> 80 Kg

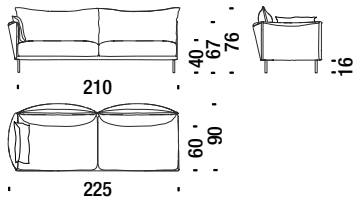

## 2 seater lateral right 225x90

### Elemento 2p destro 225x90

875

11 mt. ★ 22,5 m<sup>2</sup> 1,6 m<sup>3</sup> 80 Kg

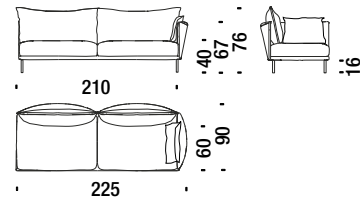

## 2 seater left peninsula 195x90

### Penisola 2p sinistra 195x90

876

9 mt. ★ 17,1 m<sup>2</sup> 1,4 m<sup>3</sup> 65 Kg

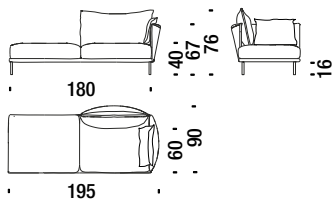

## 2 seater right peninsula 195x90

### Penisola 2p destra 195x90

877

9 mt. ★ 17,1 m<sup>2</sup> 1,4 m<sup>3</sup> 65 Kg

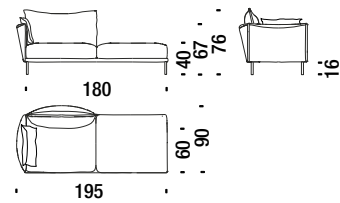

## 3 seater left peninsula 285x90

### Penisola 3p sinistra 285x90

878

13,5 mt. ★ 25,7 m<sup>2</sup> 2,1 m<sup>3</sup> 95 Kg

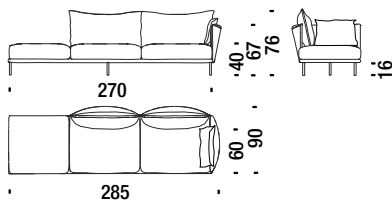

## 3 seater right peninsula 285x90

### Penisola 3p destra 285x90

879

13,5 mt. ★ 25,7 m<sup>2</sup> 2,1 m<sup>3</sup> 95 Kg

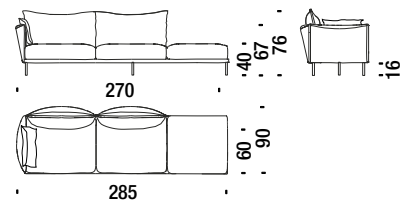

## 1 seater central element 90x105

### Elemento 1p centrale 90x105

395

5 mt. ★ 9,5 m<sup>2</sup> 0,9 m<sup>3</sup> 35 Kg

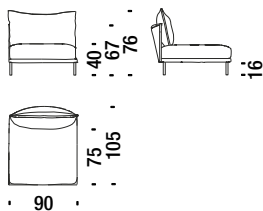

## 1 seater central element 105x105

### Elemento 1p centrale 105x105

011

6 mt. ★ 11,4 m<sup>2</sup> 0,9 m<sup>3</sup> 35 Kg

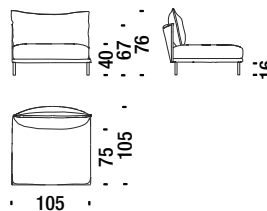

## 2 seater central element 150x105

### Elemento 2p centrale 150x105

861

8,8 mt. ★ 16,8 m<sup>2</sup> 1,3 m<sup>3</sup> 55 Kg

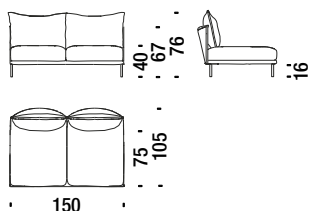

## 2 seater central element 180x105

### Elemento 2p centrale 180x105

397

9,3 mt. ★ 17,6 m<sup>2</sup> 1,4 m<sup>3</sup> 65 Kg

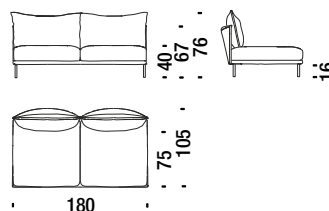

## 2 seater central element 210x105

### Elemento 2p centrale 210x105

398

10,4 mt. ★ 19,8 m<sup>2</sup> 1,7 m<sup>3</sup> 70 Kg

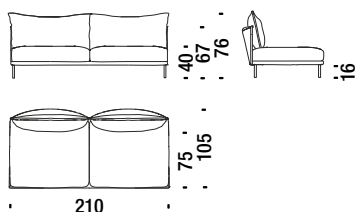

## 1 seater lateral element 105x105

### Elemento 1p laterale 105x105

053

7 mt. ★ 13 m<sup>2</sup> 0,9 m<sup>3</sup> 50 Kg

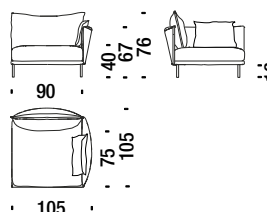

## 1 seater lateral left 120x105

### Elemento 1p sinistro 120x105

334

7,3 mt. ★ 13,9 m<sup>2</sup> 1 m<sup>3</sup> 59 Kg

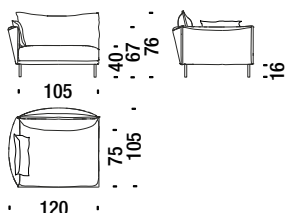

## 1 seater lateral right 120x105

### Elemento 1p destro 120x105

335

7,3 mt. ★ 13,9 m<sup>2</sup> 1 m<sup>3</sup> 59 Kg

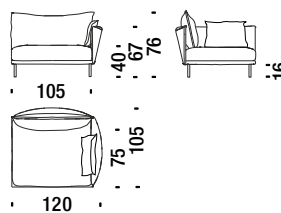

## 2 seater lateral left 165x105

### Elemento 2p sinistro 165x105

870

11 mt. ★ 21 m<sup>2</sup> 1,4 m<sup>3</sup> 60 Kg

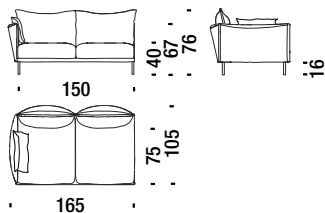

## 2 seater lateral right 165x105

### Elemento 2p destro 165x105

871

11 mt. ★ 21 m<sup>2</sup> 1,4 m<sup>3</sup> 60 Kg

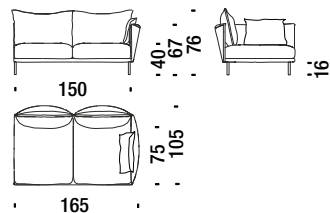

## 2 seater lateral left 195x105

### Elemento 2p sinistro 195x105

626

11,8 mt. ★ 22,5 m<sup>2</sup> 1,5 m<sup>3</sup> 70 Kg

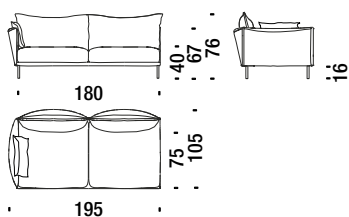

## 2 seater lateral right 195x105

### Elemento 2p destro 195x105

627

11,8 mt. ★ 22,5 m<sup>2</sup> 1,5 m<sup>3</sup> 70 Kg

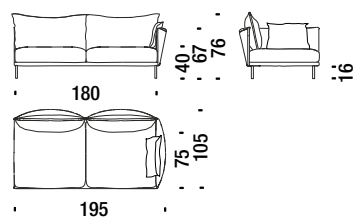

## 2 seater lateral left 225x105

### Elemento 2p sinistro 225x105

628

12,4 mt. ★ 23,6 m<sup>2</sup> 1,8 m<sup>3</sup> 93 Kg

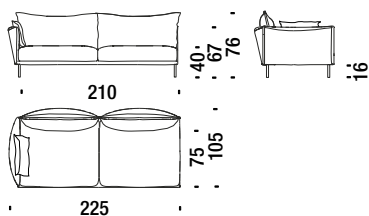

## 2 seater lateral right 225x105

### Elemento 2p destro 225x105

629

12,4 mt. ★ 23,6 m<sup>2</sup> 1,8 m<sup>3</sup> 93 Kg

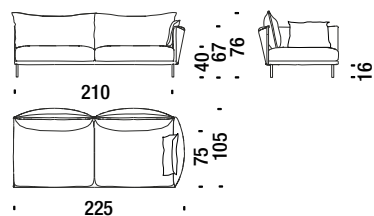

## 2 seater left peninsula 195x105

### Penisola 2p sinistra 195x105

674

9,6 mt. ★ 18,2 m<sup>2</sup> 1,4 m<sup>3</sup> 65 Kg

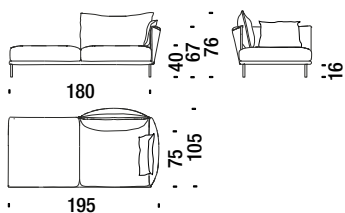

## 2 seater right peninsula 195x105

### Penisola 2p destra 195x105

675

9,6 mt. ★ 18,2 m<sup>2</sup> 1,4 m<sup>3</sup> 65 Kg

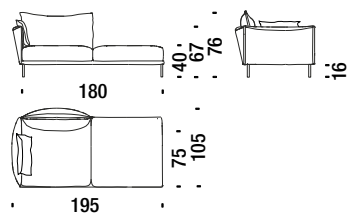

## 3 seater left peninsula 285x105

### Penisola 3p sinistra 285x105

676

14 mt. ★ 26,6 m<sup>2</sup> 2,5 m<sup>3</sup> 100 Kg

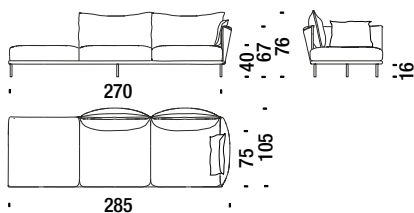

## 3 seater right peninsula 285x105

### Penisola 3p destra 285x105

677

14 mt. ★ 26,6 m<sup>2</sup> 2,5 m<sup>3</sup> 100 Kg

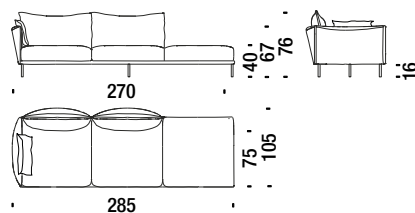

## 1 seater central element 90x120

### Elemento 1p centrale 90x120

331

5 mt. ★ 9,5 m<sup>2</sup> 1 m<sup>3</sup> 40 Kg

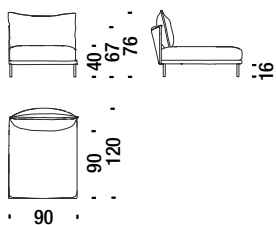

## 1 seater central element 105x120

### Elemento 1p centrale 105x120

396

6 mt. ★ 11,4 m<sup>2</sup> 1 m<sup>3</sup> 40 Kg

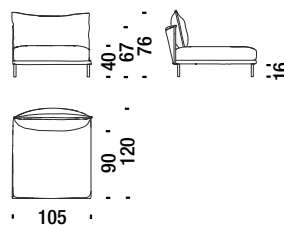

## 2 seater central element 180x120

### Elemento 2p centrale 180x120

391

9,1 mt. ★ 17,3 m<sup>2</sup> 1,6 m<sup>3</sup> 70 Kg

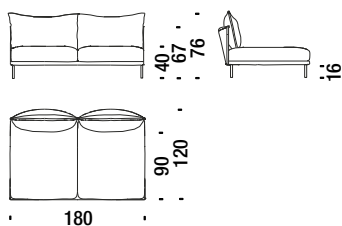

## 2 seater central element 210x120

### Elemento 2p centrale 210x120

399

11 mt. ★ 20,6 m<sup>2</sup> 1,8 m<sup>3</sup> 75 Kg

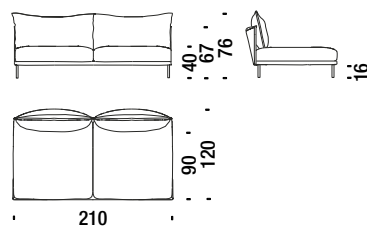

## 1 seater lateral element 120x120

### Elemento 1p laterale 120x120

052

7 mt. ★ 13 m<sup>2</sup> 1,1 m<sup>3</sup> 50 Kg

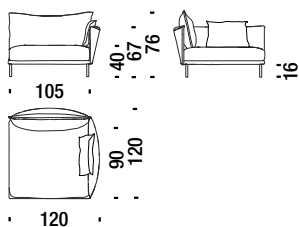

## 1 seater lateral left 105x120

### Elemento 1p sinistro 105x120

388

7,3 mt. ★ 13,9 m<sup>2</sup> 1 m<sup>3</sup> 45 Kg

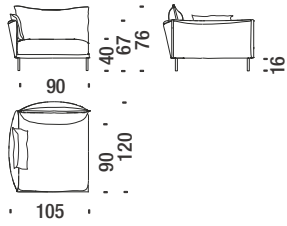

## 1 seater lateral right 105x120

### Elemento 1p destro 105x120

387

7,3 mt. ★ 13,9 m<sup>2</sup> 1 m<sup>3</sup> 45 Kg

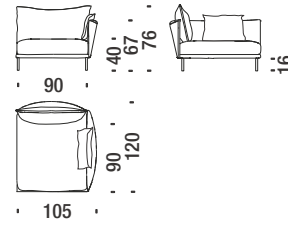

## 2 seater lateral left 195x120

### Elemento 2p sinistro 195x120

646

12,1 mt. ★ 23 m<sup>2</sup> 1,7 m<sup>3</sup> 75 Kg

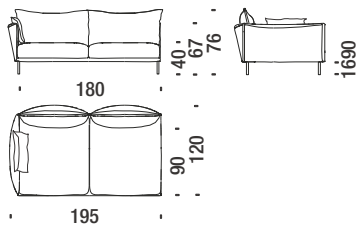

## 2 seater lateral right 195x120

### Elemento 2p destro 195x120

647

12,1 mt. ★ 23 m<sup>2</sup> 1,7 m<sup>3</sup> 75 Kg

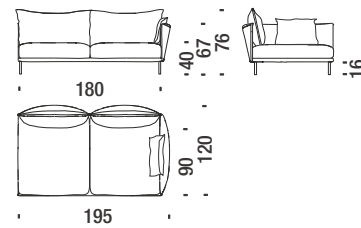

## 2 seater lateral left 225x120

### Elemento 2p sinistro 225x120

648

12 mt. ★ 23 m<sup>2</sup> 1,9 m<sup>3</sup> 90 Kg

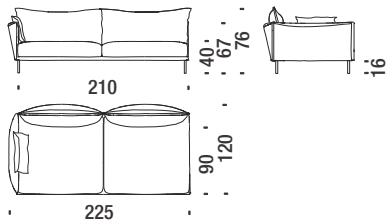

## 2 seater lateral right 225x120

### Elemento 2p destro 225x120

649

12 mt. ★ 23 m<sup>2</sup> 1,9 m<sup>3</sup> 90 Kg

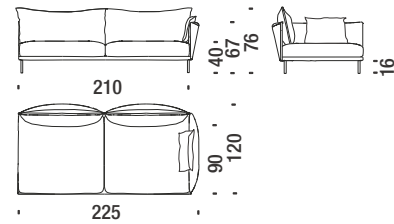

## Chaise Longue left 90x165

Chaise Longue sinistra 90x165

880

7,7 mt. ★ 14,7 m<sup>2</sup> 1,2 m<sup>3</sup> 65 Kg

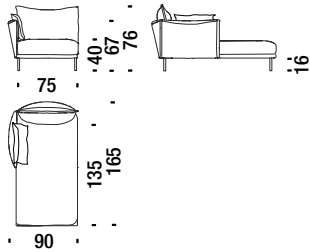

## Chaise Longue right 90x165

Chaise Longue destra 90x165

881

7,7 mt. ★ 14,7 m<sup>2</sup> 1,2 m<sup>3</sup> 65 Kg

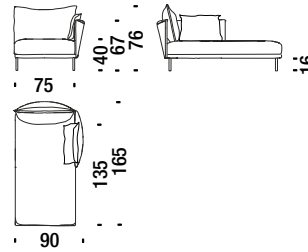

## Chaise Longue left 105x165

Chaise Longue sinistra 105x165

882

8 mt. ★ 15,2 m<sup>2</sup> 1,4 m<sup>3</sup> 70 Kg

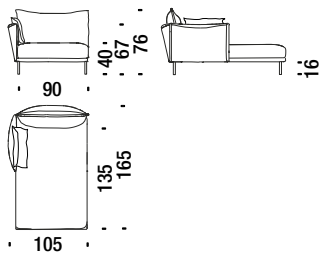

## Chaise Longue right 105x165

Chaise Longue destra 105x165

883

8 mt. ★ 15,2 m<sup>2</sup> 1,4 m<sup>3</sup> 70 Kg

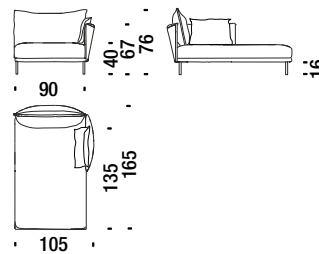

## Chaise Longue left 105x195

Chaise Longue sinistra 105x195

OD4

8,8 mt. ★ 16,8 m<sup>2</sup> 1,7 m<sup>3</sup> 85 Kg

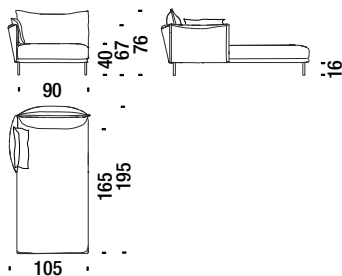

## Chaise Longue right 105x195

Chaise Longue destra 105x195

OD3

8,8 mt. ★ 16,8 m<sup>2</sup> 1,7 m<sup>3</sup> 85 Kg

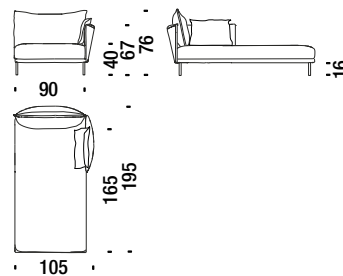

## Composition C21R or C21L

Composizione C21Dx-C21Sx

C21

17,3 mt. ★ 32 m<sup>2</sup> 2,4 m<sup>3</sup> 130 Kg

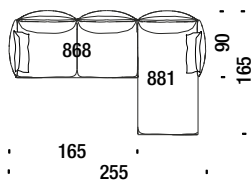

## Composition C31R or C31L

Composizione C31Dx-C31Sx

C31

18,6 mt. ★ 35,3 m<sup>2</sup> 2,6 m<sup>3</sup> 143 Kg

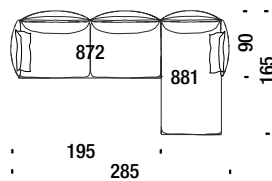

## Composition C11R or C11L

Composizione C11Dx-C11Sx

C11

17,3 mt. ★ 32 m<sup>2</sup> 2,8 m<sup>3</sup> 148 Kg

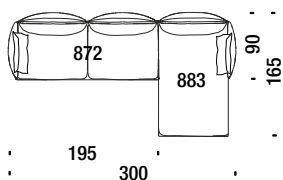

## Composition C51R or C51L

Composizione C51Dx-C51Sx

C51

17,3 mt. ★ 32 m<sup>2</sup> 3 m<sup>3</sup> 160 Kg

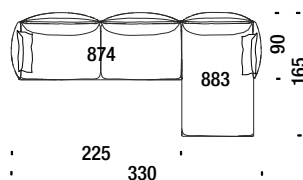

## Composition C41R or C41L

Composizione C41Dx-C41Sx

C41

17,3 mt. ★ 32 m<sup>2</sup> 2,8 m<sup>3</sup> 155 Kg

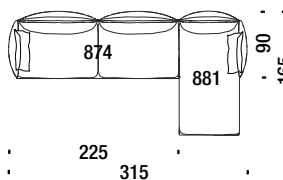

## Composition C10R or C10L

Composizione C10Dx-C10Sx

C10

18,6 mt. ★ 35,3 m<sup>2</sup> 3,2 m<sup>3</sup> 155 Kg

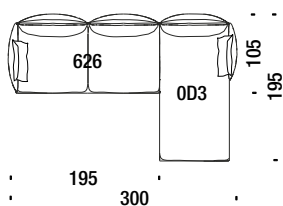

## Composition C20R or C20L

Composizione C20Dx-C20Sx

C20

18,2 mt. ★ 35 m<sup>2</sup> 3,5 m<sup>3</sup> 170 Kg

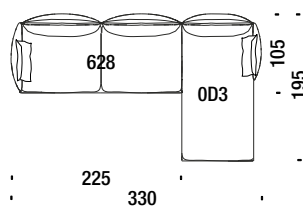

## Composition A11R or A11L

Composizione A11Dx-A11Sx

A11

20 mt. ★ 38 m<sup>2</sup> 2,7 m<sup>3</sup> 120 Kg

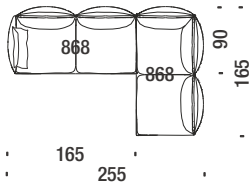

## Composition A21R or A21L

Composizione A21Dx-A21Sx

A21

21,8 mt. ★ 41,4 m<sup>2</sup> 2,6 m<sup>3</sup> 120 Kg

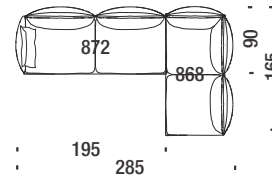

## Composition A31R or A31L

Composizione A31Dx-A31Sx

A31

21,8 mt. ★ 41,4 m<sup>2</sup> 2,8 m<sup>3</sup> 130 Kg

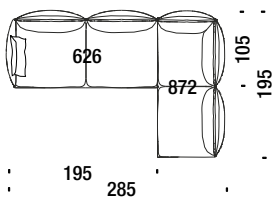

## Composition A41R or A41L

Composizione A41Dx-A41Sx

A41

21,8 mt. ★ 41,4 m<sup>2</sup> 2,8 m<sup>3</sup> 125 Kg

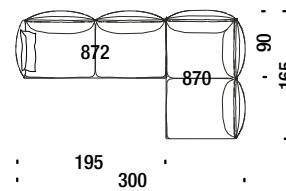

## Composition A10R or A10L

Composizione A10Dx-A10Sx

A10

22 mt. ★ 42 m<sup>2</sup> 3 m<sup>3</sup> 140 Kg

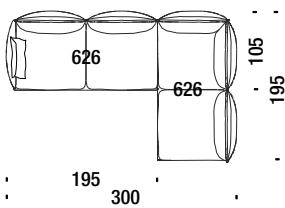

## Composition A20R or A20L

Composizione A20Dx-A20Sx

A20

22 mt. ★ 42 m<sup>2</sup> 3,3 m<sup>3</sup> 155 Kg

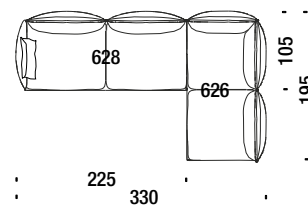

## Composition A30R or A30L

Composizione A30Dx-A30Sx

A30

22 mt. ★ 42 m<sup>2</sup> 3,4 m<sup>3</sup> 155 Kg

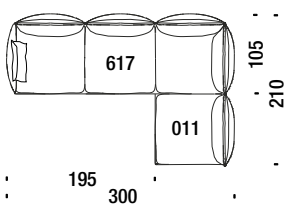

## Composition A40R or A40L

Composizione A40Dx-A40Sx

A40

24,5 mt. ★ 46,6 m<sup>2</sup> 3,6 m<sup>3</sup> 160 Kg

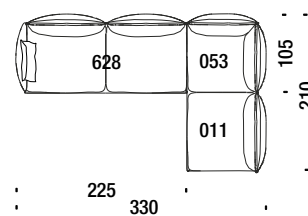



## Composition B10R or B10L

Composizione B10Dx-B10Sx

B10

23 mt. ★ 43,7 m<sup>2</sup> 3,2 m<sup>3</sup> 145 Kg

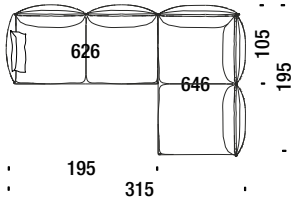

## Composition B20R or B20L

Composizione B20Dx-B20Sx

B20

23 mt. ★ 43,7 m<sup>2</sup> 3,4 m<sup>3</sup> 155 Kg

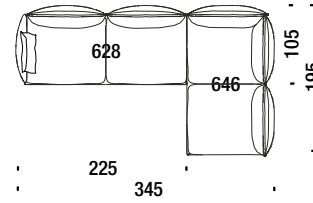

## Composition B30R or B30L

Composizione B30Dx-B30Sx

B30

25 mt. ★ 47,5 m<sup>2</sup> 3,6 m<sup>3</sup> 165 Kg

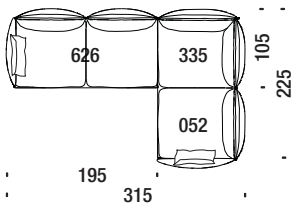

## Composition B40R or B40L

Composizione B40Dx-B40Sx

B40

25 mt. ★ 47,5 m<sup>2</sup> 3,9 m<sup>3</sup> 180 Kg

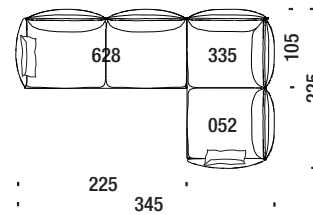

## Composition A51R or A51L

Composizione A51Dx-A51Sx

A51

26,3 mt. ★ 50 m<sup>2</sup> 3,5 m<sup>3</sup> 165 Kg

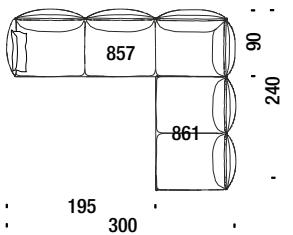

## Composition A61R or A61L

Composizione A61Dx-A61Sx

A61

27 mt. ★ 51,3 m<sup>2</sup> 3,6 m<sup>3</sup> 170 Kg

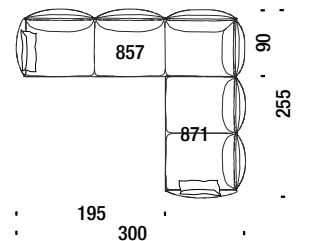

## Composition A50R or A50L

Composizione A50Dx-A50Sx

A50

28 mt. ★ 53,2 m<sup>2</sup> 4 m<sup>3</sup> 190 Kg

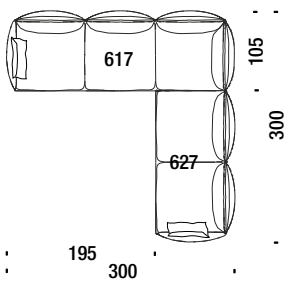

## Composition A60R or A60L

Composizione A60Dx-A60Sx

A60

28 mt. ★ 53,2 m<sup>2</sup> 4,3 m<sup>3</sup> 222 Kg

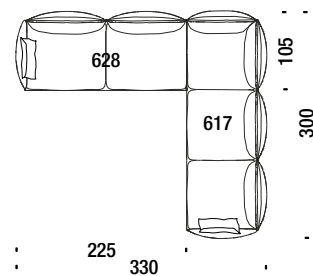

## Composition B50R or B50L

### Composizione B50Dx-B50Sx

B50

30 mt. ★ 57 m<sup>2</sup> 4,2 m<sup>3</sup> 190 Kg

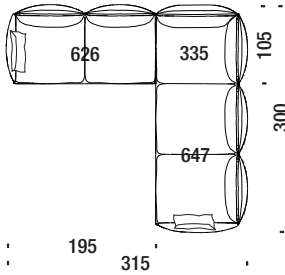

## Composition B60R or B60L

### Composizione B60Dx-B60Sx

B60

30 mt. ★ 57 m<sup>2</sup> 4,5 m<sup>3</sup> 205 Kg

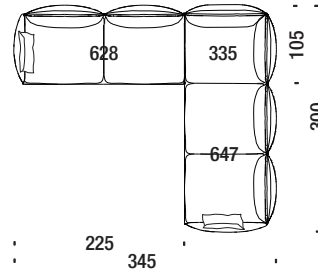

## Composition B70R or B70L

### Composizione B70Dx-B70Sx

B70

30 mt. ★ 57 m<sup>2</sup> 4,5 m<sup>3</sup> 205 Kg

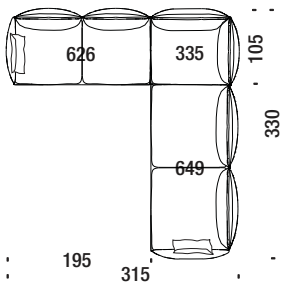

## Composition B80R or B80L

### Composizione B80Dx-B80Sx

B80

30 mt. ★ 57 m<sup>2</sup> 4,7 m<sup>3</sup> 220 Kg

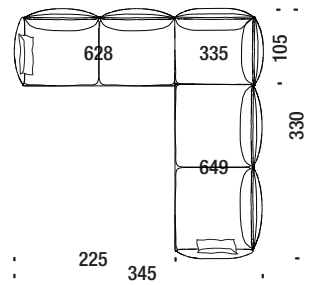

## Composition A70R or A70L

### Composizione A70Dx-A70Sx

A70

28 mt. ★ 53,2 m<sup>2</sup> 4,3 m<sup>3</sup> 205 Kg

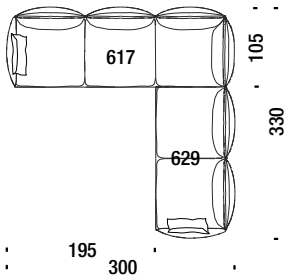

## Composition A80R or A80L

### Composizione A80Dx-A80Sx

A80

28 mt. ★ 53,2 m<sup>2</sup> 4,5 m<sup>3</sup> 210 Kg

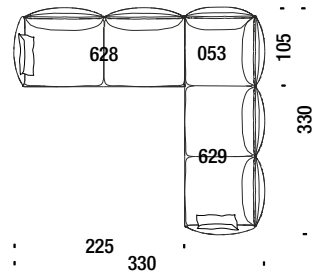

## Composition A71R or A71L

### Composizione A71Dx-A71Sx

A71

31,5 mt. ★ 60 m<sup>2</sup> 3,6 m<sup>3</sup> 165 Kg

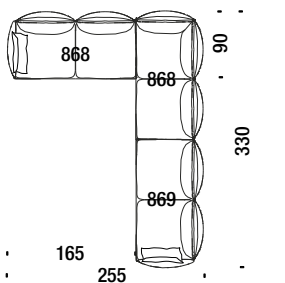

## Composition A81R or A81L

### Composizione A81Dx-A81Sx

A81

31,5 mt. ★ 60 m<sup>2</sup> 3,8 m<sup>3</sup> 175 Kg

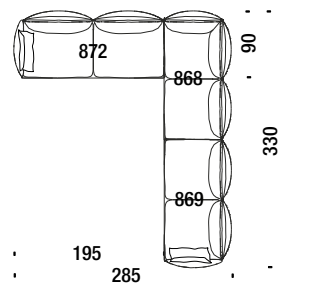

## Composition A90R or A90L

### Composizione A90Dx-A90Sx

A90

22 mt. ★ 42 m<sup>2</sup> 3,5 m<sup>3</sup> 165 Kg

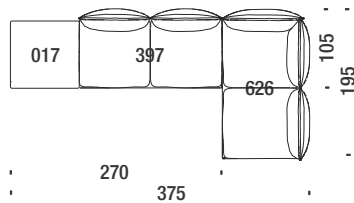

## Composition B90R or B90L

### Composizione B90Dx-B90Sx

B90

34,1 mt. ★ 65 m<sup>2</sup> 4,4 m<sup>3</sup> 205 Kg

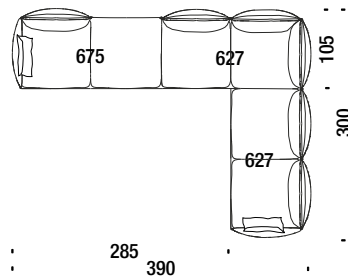

## Composition C50R or C50L

### Composizione C50Dx-C50Sx

C50

36,1 mt. ★ 66,2 m<sup>2</sup> 5,7 m<sup>3</sup> 255 Kg

