

FREESTYLE — FERRUCCIO LAVIANI 2006

1—
5



Maximum modularity for this agile and versatile system. ranging from the more classic three-seat sofa to an island with opposed seating, Ferruccio Laviani deconstructed and reformulated the entire conversation area. There are three alternatives in the design of the armrests. A vertical element placed beside the seat module completes the design of the backrests, offering a comfortable surface to lean to; a low cushion integrated in the seat body, a discrete support where to lie down, stretch out and eventually fall asleep; a trapezoid end piece that can further increase the possible composition forms.

FEATURES

Freestyle is a modular system that exploits the endless combination possibilities of the pieces available to create linear and corner solutions with the greatest freedom in terms of size. The seats can be joined to backs in varying sizes symmetrically or asymmetrically, playing with the cover colours to create combinations in different shades or more traditional single-colour solutions. Freestyle also has two types of arm: a classical piece that flank the structure level with the back or a side cushion that forms one with the seat. As well as the traditional seats there is also a trapezoid end piece, an island element and chaise longue that can further increase the possible composition forms. Freestyle is completed by additional back cushions in three sizes that can be used in the number and fabric type desired. The stitching on the front of the seat and arm lends further elegance to the product.

DATASHEET

I.2015

molteni.it

Dimensions in millimeters and inches. The right to discontinue and make changes is reserved. This information is based on the latest product information available at the time of printing.

FINISHES

COVERS

fabric - leather, completely removable.

Available in fire-resistant version (TB117 and BS5852).

Molteni & C

TECHNICAL INFORMATION

SEAT

Internal structure is a solid firwood (Picea abies) frame and chipboard, with elastic straps. Padding in variable density high-resistance foam polyurethane. Light velvet cover.

SEAT WITH CUSHIONS

Internal structure is a solid firwood (Picea abies) frame and chipboard, with elastic straps. Padding in variable density high-resistance foam polyurethane. Light velvet cover. Cushion filled with flakes polyurethane and sterilised feathers, 100% cotton cover.

ARM AND BACK

Internal structure is a solid firwood (Picea abies) frame and chipboard, with elastic straps. Padding in variable density high-resistance foam polyurethane. Light velvet cover.

ADDITIONAL CUSHIONS

Cushion filled with flakes polyurethane and sterilised feathers, 100% cotton cover.

FRAME WITH FEET

Painted metal with adjustable feet in non-slip plastic.

REMOVABLE OUTER COVERS

(See attached card, specific for each cover).

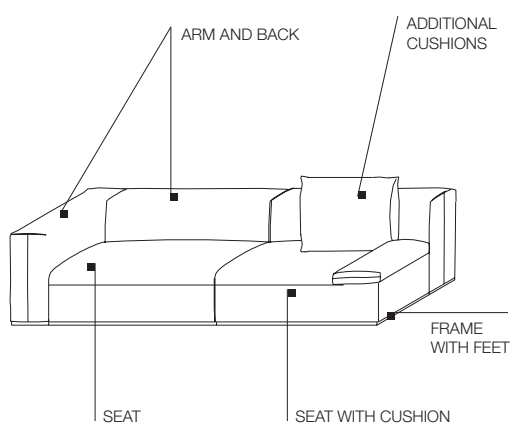

DATASHEET

I.2015

DIMENSIONS

Asymmetric back example

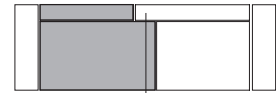
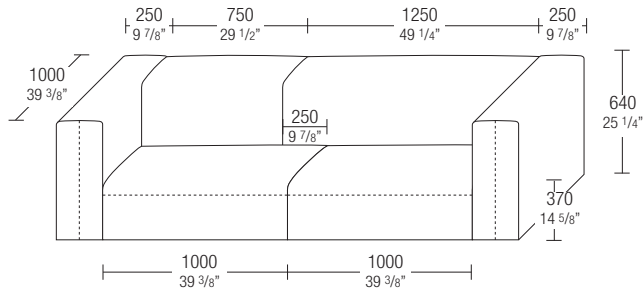

The seat-back alignment can differ by a maximum of 250 mm (9 7/8")

Seats with cushion arm

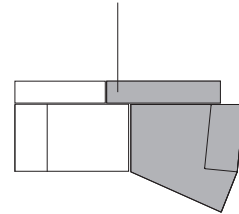
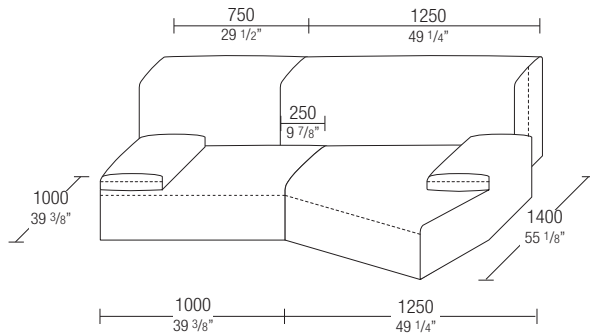

Island element

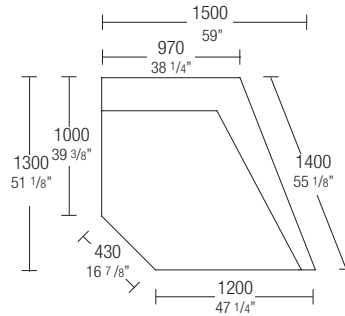
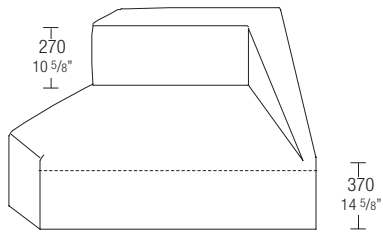

Chaise longue

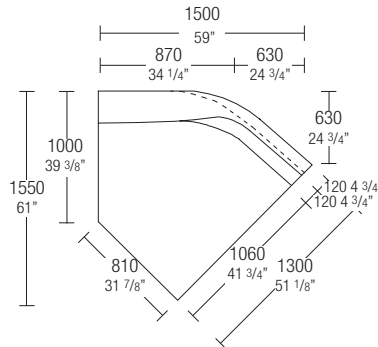
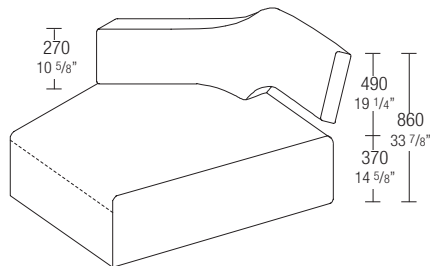

The elements next to an island or a chaise longue must have the seat and the back aligned.

DIMENSIONS

seats

W 1250 D 750 H 370
W 49 1/4" D 29 1/2" H 14 5/8"

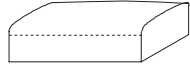

SE12

W 1000 D 750 H 370
W 39 3/8" D 29 1/2" H 14 5/8"

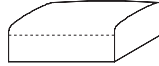

SE10

W 750 D 750 H 370
W 29 1/2" D 29 1/2" H 14 5/8"



SE75

Molteni & C

seats with cushion

W 1250 D 750 H 370/500
W 49 1/4" D 29 1/2" H 14 5/8" - 19 3/4"
cushion W 350
cushion W 13 3/4"

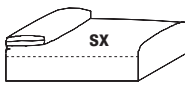

SC12 dx - sx

W 1000 D 750 H 370/500
W 39 3/8" D 29 1/2" H 14 5/8" - 19 3/4"
cushion W 350
cushion W 13 3/4"

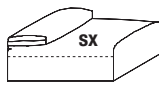

SC10 dx - sx

end

W 1250 D 750/1140 H 370
W 49 1/4" D 29 1/2" - 44 7/8" H 14 5/8"



TE12 dx - sx

end with cushion

W 1250 D 750/1140 H 370/500
W 49 1/4" D 29 1/2" - 44 7/8" H 14 5/8" - 19 3/4"
cushion W 350
cushion W 13 3/4"

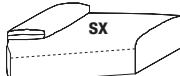

TC12 dx - sx

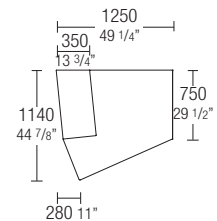

back

W 1250 D 250 H 640
W 49 1/4" D 9 7/8" H 25 1/4"



SH12

W 1000 D 250 H 640
W 39 3/8" D 9 7/8" H 25 1/4"



SH10

W 750 D 250 H 640
W 29 1/2" D 9 7/8" H 25 1/4"

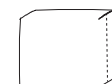

SH75

arm

W 250 D 1000 H 640
W 9 7/8" D 39 3/8" H 25 1/4"



BR10

pouf

W 1250 D 1000 H 370
W 49 1/4" D 39 3/8" H 14 5/8"

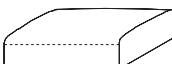

PF12

W 1000 D 1000 H 370
W 39 3/8" D 39 3/8" H 14 5/8"

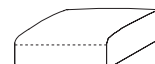

PF10

pouf

W 750 D 750 H 370
W 29 1/2" D 29 1/2" H 14 5/8"



PF7575

W 1000 D 750 H 370
W 39 3/8" D 29 1/2" H 14 5/8"



PF1075

W 1250 D 750 H 370
W 49 1/4" D 29 1/2" H 14 5/8"



PF1275

DATASHEET

DIMENSIONS

island element

W 1500 D 1300 H 640
W 59" D 51 1/8" H 25 1/4"

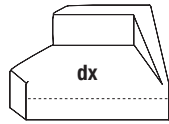

IS15 dx - sx

chaise longue

W 1500 D 1550 H 640/860
W 59" D 61" H 25 1/4" - 33 7/8"

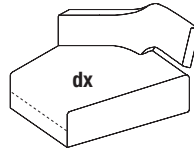

CL15 dx - sx

additional cushions

W 800 H 600
W 31 1/2" H 23 5/8"



CU80

W 700 H 600
W 27 1/2" H 23 5/8"



CU70

W 600 H 600
W 23 5/8" H 23 5/8"



CU60

SAMPLE COMPOSITIONS

composition 5

W 2250 D 1000/1390
W 88 5/8" D 39 3/8" - 54 3/4"

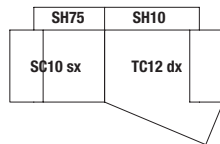

L05

composition 37

W 3750 D 1000/1550
W 147 5/8" D 39 3/8" - 61"

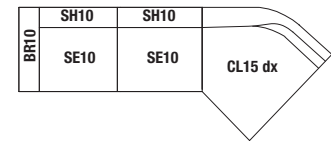

L37

composition 11

W 4250 D 2500
W 167 3/8" D 98 3/8"

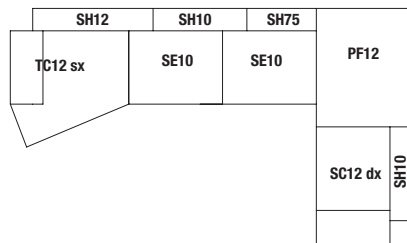

A11