

LOWE FURNITURE

MONTEREY SIDE

PLAN

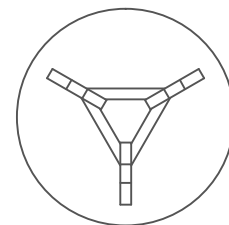
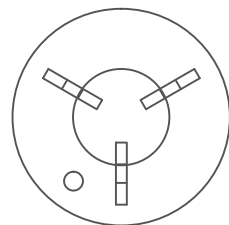
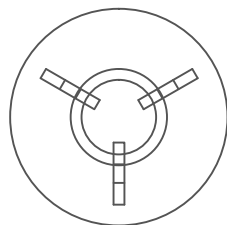

ELEVATION

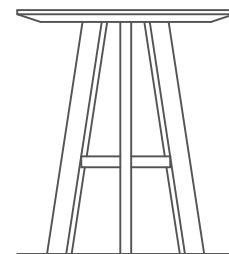
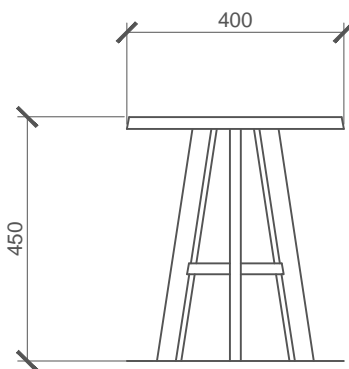
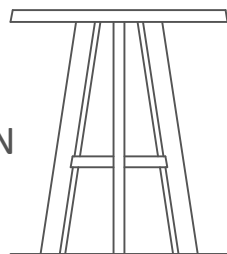

NOEL

MITCH

JIMI

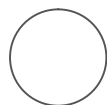
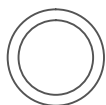

ALL PIECES ARE AVAILABLE IN STANDARD AND CUSTOM SIZES
THIS DRAWING IS FOR ILLUSTRATION PURPOSES ONLY

14.05.2013
This design remains the property of Lowe Furniture. This drawing is not
to be duplicated or distributed without the consent of Lowe Furniture

Lowe Furniture is a local manufacturing company based in Melbourne, Australia. Owned and founded by Andrew Lowe in 2000, Lowe Furniture's vision is to recreate the beauty and seamlessness of nature within a space where people live and work.

Lowe Furniture is deeply passionate about timber. This combined with extensive timber knowledge, design skills and precision handcrafted manufacturing, means Lowe Furniture produce timeless timber pieces

Timber is a renewable resource and Lowe Furniture vigorously strives to work only with plantation and Forestry Stewardship (FSC) timbers. Lowe Furniture avoids working with rainforest timbers.

Lowe Furniture predominantly work with American hardwoods, including oak and walnut. Like a tree in the ground, timber reacts to its environment and naturally changes over time. The Lowe Furniture design and manufacturing process closely considers such change, however, each tree and therefore piece of timber is unique and all changes cannot be accounted for in any design and manufacturing process.

Warranty

Lowe Furniture provides a five year warranty on products excluding outdoor products (refer below).

Lowe Furniture warrants any manufacturing defects but does not cover and specifically excludes:

- > faulty materials and or any other components procured by Lowe Furniture from third parties
- > product damaged during transit , installation, moving or removal including damage to third party property and any related transport and rectification costs
- > a product damaged as a result of using it for non-intended purposes
- > a product damaged through normal or excess wear and tear including but not limited to scratches, cracks, chips, burns, stains, discolouring and shadowing
- > a product damaged during any cleaning process
- > damage including joint separation, timber changes or movements such as bowing, as a result of the product being exposed to heat, sunlight, excessive humidity or moisture and fluctuations in temperature.

Outdoor Product Warranty

Lowe Furniture provides a one year guarantee on outdoor products relating only to the structural integrity of the product. Whilst all outdoor products are made to counter the elements, the warranty excludes any changes or damage as a result of any exposure to outside weather of any kind. The exclusions listed above also apply to outdoor products.

All warranty claims should be made through the place of purchase. The warranty provided relates only to the cost of replacing or repairing the product and excludes any transport and any other costs related to the warranty claim.

LOWE FURNITURE.



Caring for & Cleaning a Lowe Furniture Product

Lowe Furniture recommends the use of a warm damp (water only) rag or sponge to clean a product. When cleaning, do not rub vigorously in one spot. Abrasive cleaners and /or polishes should not be used.

Heat

Lowe Furniture products should not be exposed to excessive or constant heat. For example hot plates and cups may burn, damage or discolour the timber. Lowe Furniture products should not be placed close to heaters, over heating vents, or next to something that permits excessive or a constant heat.

Sunlight

Lowe Furniture recommends that a product not be exposed to excessive sunlight which may cause the timber colour to change over time and the timber to shrink.

Humidity and Moisture

Lowe Furniture products should not be exposed to excessive humidity or moisture, which may cause damage to the timber e.g. if the space in which the product is located has a dampness problem, this may affect the product.

LOWE
FURNITURE.